



HEALTHCARE PRODUCTS  
2015-16



HTM 71 AND HTM 63 SYSTEMS | PROCEDURE TROLLEYS | WARD EQUIPMENT | STERILISATION STORAGE | MODULAR STORAGE SYSTEMS |  
LOGISTICS AND PRODUCT HANDLING | MEDICATION CARTS | LAUNDRY AND LINEN CARTS | SOLUTIONS FOR THE HEALTHCARE SECTOR |

TOTAL SPACE UTILISATION

# HEALTHCARE PRODUCTS 2015-2016

STORAGE, LOGISTICS AND PRODUCT HANDLING SOLUTIONS

## TOTAL SPACE UTILISATION

Medstor is the UK's most focused healthcare materials management and logistics provider.

As one of the leading UK manufacturers we take pride in our commitment to both quality and service, whilst continually investing in the development of new innovative products specifically targeted at the healthcare sector.

Our vast healthcare product portfolio provides numerous user benefits to improve any busy working environment.

ALL OUR SYSTEMS SAVE TIME, SPACE AND COSTS...

## CONTACT US:

FREE PROJECT ADVICE SERVICE

Medstor - Stamford Products Ltd

Bayley Street, Stalybridge, Cheshire, SK15 1QQ.

CALL:

+44 (0)161 330 5577

EMAIL:

health@medstor.co.uk

FAX:

+44 (0)161 330 5576

Please visit: [www.medstor.co.uk](http://www.medstor.co.uk)



# CONTENTS

EVERY STEP OF THE WAY	01-05
HEALTHCARE SYSTEMS	06-11
ACCREDITATIONS & ASSOCIATIONS	12-15
STORAGE AND PROTECTION	16-17
TRAYS AND LINER SYSTEM	18-29
HTM71 CABINET SYSTEM	30-51
SPECIALIST CABINETS	52-63
BEDSIDE CABINETS AND TABLES	64-65
HTM 63	66-77
MODULAR NURSES STATIONS	78-79
STOCK CONTROL HTM 71 SHELVING SOLUTIONS	80-85
METRO SHELVING SYSTEMS	86-93
STERILE SERVICES, CSSD, INFECTION PREVENTION AND CONTROL	94-117
MODULE CARTS AND PROCEDURE TROLLEYS	118-135
TECHNOLOGY	136-149
LAUNDRY & CONTRACT COLLECTION	150-159
WASTE COLLECTION	160-162
INDEX	163-165
INFORMATION	166
CONTAINER MATERIALS & CONVERSION FORMULAE	167



MEDSTOR TRAYS:  
The true heart of our very own UK manufactured storage systems.

## **EVERY STEP OF THE WAY**

CONSULTATION, SPACE PLANNING, PRODUCT DESIGN AND INSTALLATION

ALL WITHIN YOUR BUDGET

**From a single room to a complete hospital, we will work with you from start to finish.**

**Our services don't just end after the installation, it's important to us that you are 100% satisfied with all aspects of the Medstor products and services: Post installation, fine tuning and extensive warranty offers, plus long term after sales service will give you peace of mind for continual use.**

# Assessment

Our leading healthcare representatives begin by assessing your current situation in terms of materials holding, throughput, space planning and working practices. After consultation we will develop a tailored individual plan using current best practice to implement change.



# Preparation

We offer a free site survey and planning service from our very own in-house team. Personalised layout plans and 3D visuals can be produced of your project along with a fully itemised product matched Medstor quotation.

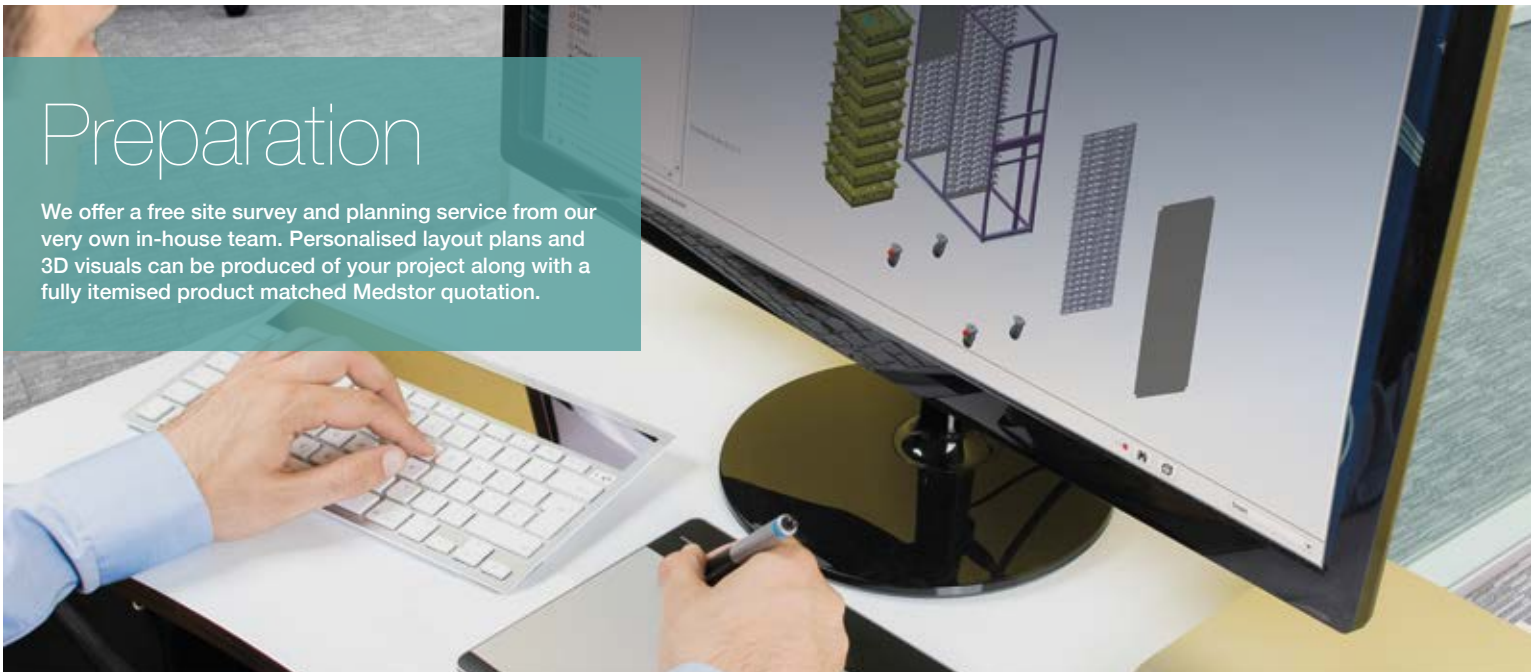

# Installation

Our CSCS qualified installation teams will ensure that your products are fitted, cleaned and left ready for use.

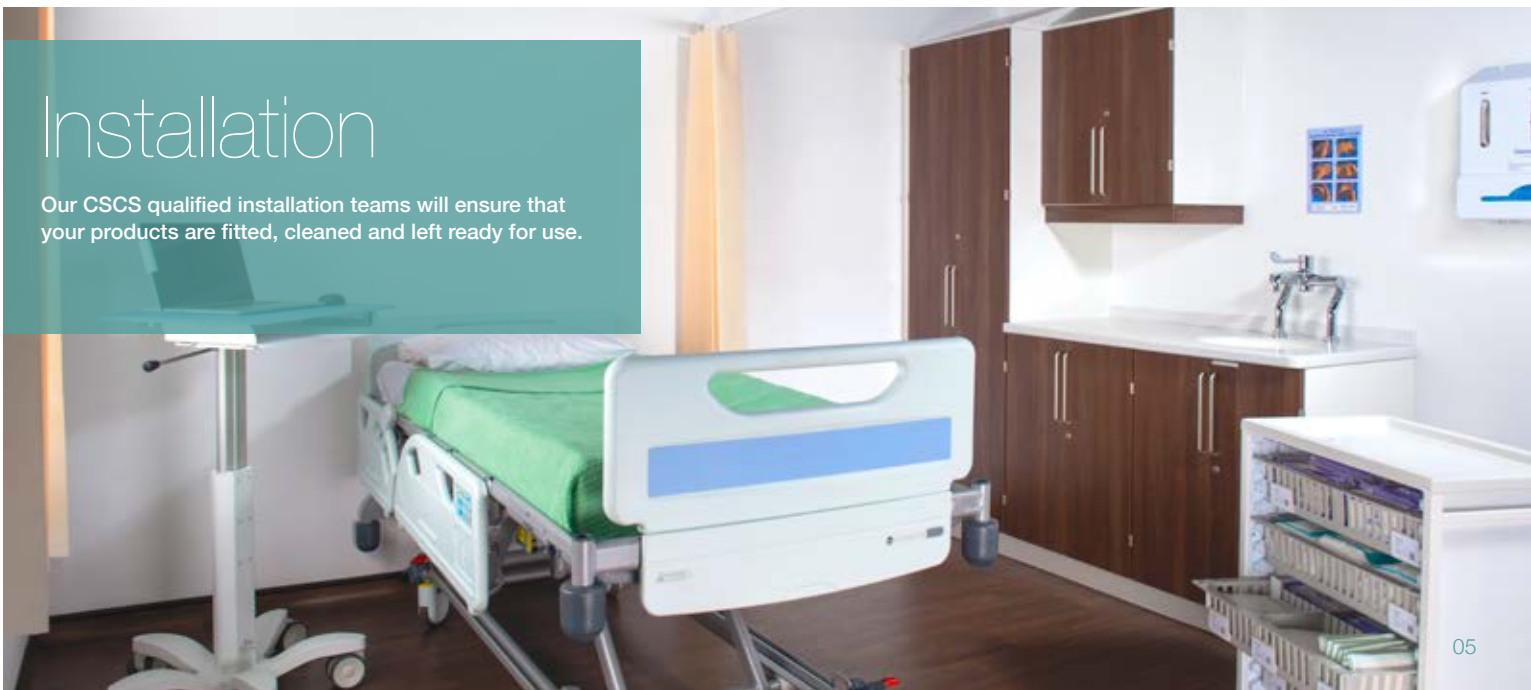



**HEALTHCARE SYSTEMS**

HTM71, HTM63 AND CSSD SPECIALISTS

MATERIALS MANAGEMENT EXPERTS

All Northern Ireland Trusts  
Barnsley Hospital NHS Foundation Trust  
Central Manchester University Hospitals NHS Foundation Trust  
Sheffield Teaching Hospitals NHS Foundation Trust  
Northern Lincolnshire and Goole Hospitals NHS Foundation Trust  
Harrogate and District NHS Foundation Trust  
Royal Free London NHS Foundation Trust  
Cambridge University Hospitals NHS Foundation Trust  
Oxford University Hospitals NHS Trust (OUH)  
West Hertfordshire Hospitals NHS Trust  
South Glasgow University Hospital, NHS Greater Glasgow & Clyde  
Royal Hospital for Sick Children (Yorkhill), NHS Greater Glasgow & Clyde  
Aberdeen Royal Infirmary, NHS Grampian  
Dumfries and Galloway Royal Infirmary, NHS Dumfries & Galloway  
University College Hospital Galway  
St Vincent's University Hospital  
Our Lady's Children's Hospital Crumlin  
St James's Hospital  
Cork University Hospital,  
University Hospital Limerick  
Kerry General Hospital  
University Hospital Waterford  
Morriston Hospital, Abertawe Bro Morgannwg University Health Board  
Princess of Wales Hospital, Abertawe Bro Morgannwg University Health Board  
University Hospitals Bristol NHS Foundation Trust  
The Royal Bournemouth & Christchurch Hospitals NHS Foundation Trust  
Northern Devon Healthcare NHS Trust



### See what our customers have to say...

Please request any number of case studies available to see how we can take your project from start to completion.

Our projects range from a small GP practice to complete hospital refurbishments and new builds, working with Architects and product specifiers throughout the UK and Ireland.

With completed projects throughout Europe, USA & Canada, GGS, Asia and Australasia, Medstor is a truly global healthcare brand.

View online: [www.medstor.co.uk](http://www.medstor.co.uk)

Check our web site for overseas distributors.







# HEALTHCARE SHOWROOM

WITH PURPOSE BUILT DEMONSTRATION AREAS

## TAKE THE MEDSTOR TOUR

Our head office houses a large number of the latest Medstor products available for presentation. Please contact us to arrange an informal viewing of our showroom. Pre-arranged tours of our manufacturing processes are also available.





**QUALITY ASSURANCE**  
PRODUCT GUARANTEE

# Reducing consumption!

## ENVIRONMENTAL IMPACT

DEVELOPING PRODUCTS WITH EFFICIENT USE OF MATERIALS



Medstor - Stamford Products Ltd are committed to Innovation, Collaboration, Process Improvement and Sustainability reporting.

### ECO

Our business plans honour our place in the community as we work to minimise the impact of our operations, in a way which protects and enhances the environment and society.



### Organic

Reducing consumption!

### EARTH



### Bio

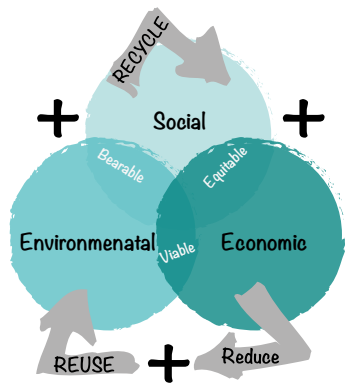

= SUSTAINABLE DEVELOPMENT!



## WORKING SMART ACCREDITATIONS & ASSOCIATIONS

### ENGLAND

NHS SUPPLY CHAIN : CONTRACT REF: FAG15887 MEDICAL FURNITURE.

### NORTHERN IRELAND

CONTRACT REF: 3166 Supply, Delivery and Installation of Modular Storage Systems for Materials Management including Survey and Design.

CONTRACT REF: 11128 Supply and Delivery of Ward Trolleys and Associated Equipment.

### SCOTLAND GG & C

CONTRACT REF: 2013/S 104-178041 Storage Solutions for Clinical Areas (HTM71).

### IRELAND

Contract Ref: HSE 049/12 – Kanban Modular Storage System.



ISO 9001: 2008

BS8555: 2003 Part 1, 2, 3, 4 & 5

ISO 3394: 2012 Packaging

Quality Management System.

Environmental Management Systems.

Complete, filled transport packages and unit loads.

Dimensions of rigid rectangular packages.

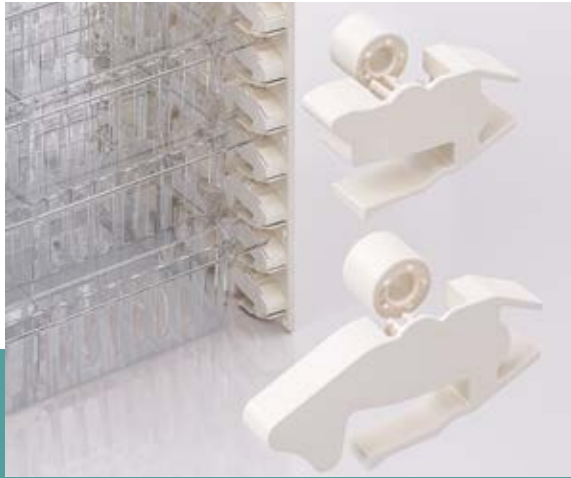

**New for 2015:**  
Wheeled liner and arrester system, developed by our own product design team.



**Module Healthcare carts:**  
Flexibility of design and purpose with a range of accessories to customise for function.



**Nurses stations:**  
A collection of modular units combine to give a personalised work area.

## HEALTHCARE PRODUCT DESIGN

BESPOKE PRODUCT DESIGN TO OUR BIM PROJECT LIBRARY

# RESEARCH AND DEVELOPMENT

The development of new innovative healthcare products is, as always, of great importance to us. Our design team are constantly working with healthcare professionals at ground level to provide products that benefit our customers on a day to day basis across the whole working environment.

High quality, cost effective, sustainable U.K. manufacturing has always been the key to our successful design ethos.





**BEAUTY IN SIMPLICITY...**

OUT OF CLUTTER, FIND SIMPLICITY.  
FROM DISCORD, FIND HARMONY.  
IN THE MIDDLE OF DIFFICULTY LIES OPPORTUNITY.



# STORAGE & PROTECTION

POLYCARBONATE OR ABS TRAYS AND DIVIDERS

## BEST IN CLASS

The extremely strong, robust and smooth Medstor trays and dividers are above all designed to protect their contents.

High temperature washing machine compliant materials are used to ensure hygienic surfaces within your environment.

IDEALLY SUITED TO THE RIGOURS OF ANY BUSY HOSPITAL.







# CLEAR POLYCARBONATE

15 YEAR PRODUCT GUARANTEE

- Load bearing capacity 35kg
- High impact break resistant
- Suitable to be sanitised at both high and low temperatures
- Conform to international module sizes
- Full integration between trays and dividers
- Solid base options protect from fluid leaks
- Perforated base options improve air flow
- Inbuilt cabinet drawer stops
- Seamless hygienic design
- Nestable same size containers

DESIGNED AND MANUFACTURED IN THE UK BY MEDSTOR  
Giving us total system control and product continuity.

POLYCARBONATE TRAYS AVAILABLE IN 3 DEPTHS  
50mm, 100mm & 200mm sizes



Temperature range -40°C to +120°C

#### A: LONG DIVIDERS

Slot into the tray wall to start configuration.

#### B: SHORT DIVIDERS

Sit into the long divider to create robust secured compartments.

#### C: SNAPPABLE DIVIDERS

Insert in any orientation to maximise tray configuration, support with T Clip.

#### D: LABEL HOLDERS

Portrait and landscape fitting see page 25 for all options.

#### E: T-CLIP

Used with snappable dividers to support open ends. Code F112.

# PRACTICAL APPLICATIONS

ORGANISATION - IDENTIFICATION - TRANSPORTATION



Supports multiple level stock control systems, Kanban, FIFO, Scan and Go. See page 146 for additional RFID information.



Organise stock into configured trays to maximise space utilisation and positioned to create a safe storage environment.



Trays are fully compatible with all Medstor cabinets, shelving systems and trolley ranges.



## EURO SIZE 600 x 400

Clear polycarbonate makes identifying materials easy, with a user temperature range of -40°C to +120°C machine wash and resistant to standard detergents.

W (mm)	D (mm)	H (mm)
600	400	50
600	400	100
600	400	200



**OPEN SIDES AND SOLID BASE**

-
M1601
M1602



**OPEN SIDES AND OPEN BASE**

-
M1651
-



**SOLID SIDES AND SOLID BASE**

M1605
M1611
M1612

## POLYCARBONATE DIVIDERS

Correspond to relevant tray heights.



**SHORT DIVIDER 400 D (mm)**

M1645
M1641
M1642



**LONG DIVIDER 600 D (mm)**

M1665
M1661
M1662



## COMPACT SIZE 400 x 300

Clear polycarbonate makes identifying materials easy, with a user temperature range of -40°C to +120°C machine wash and resistant to standard detergents.

W (mm)	D (mm)	H (mm)
400	300	50
400	300	100
400	300	200



**OPEN SIDES AND SOLID BASE**

-
M1301
M1302



**OPEN SIDES AND OPEN BASE**

-
-
-



**SOLID SIDES AND SOLID BASE**

M1305
M1311
M1312

## POLYCARBONATE DIVIDERS

Correspond to relevant tray heights.



**SHORT DIVIDER 300 D (mm)**

M1635
M1631
M1632



**LONG DIVIDER 400 D (mm)**

M1645
M1641
M1642

# ABS

## 10 YEAR PRODUCT GUARANTEE

- Load bearing capacity of 35kg
- Good impact strength
- Conform to international module sizes
- Full integration between trays and dividers
- Solid base options protect from fluid leaks
- Perforated base options improve air flow
- Inbuilt cabinet drawer stops
- Seamless hygienic design
- Nestable same size containers

DESIGNED AND MANUFACTURED IN THE UK BY MEDSTOR  
Giving us total system control and product continuity.

ABS TRAYS AVAILABLE IN 3 DEPTHS  
50mm, 100mm & 200mm sizes



Temperature range -20 °C to +60°C

### A: LONG DIVIDERS

Slot into the tray wall to start configuration.

### B: SHORT DIVIDERS

Sit into the long divider to create robust secured compartments.

### C: SNAPPABLE DIVIDERS

Insert in any orientation to maximise tray configuration, support with T Clip.

### D: LABEL HOLDERS

Portrait and landscape fitting see page 25 for all options.

### E: T-CLIP

Used with snappable dividers to support open ends. Code F112.

# PRACTICAL APPLICATIONS

ORGANISATION - IDENTIFICATION - TRANSPORTATION



Supports multiple level stock control systems, Kanban, FIFO, Scan and Go. See page 146 for additional RFID information



Organise stock into configured trays to maximise space utilisation and positioned to create a safe storage environment.



Trays are fully compatible with all Medstor cabinets, shelving systems and trolley ranges.



## EURO SIZE 600 x 400

ABS offers a tidy container solution, with a user temperature range of -20°C to +60°C resistant to standard detergents.

W (mm)	D (mm)	H (mm)
600	400	50
600	400	100
600	400	200



**OPEN SIDES AND SOLID BASE**

-
M0601
M0602



**OPEN SIDES AND OPEN BASE**

-
M0651
-



**SOLID SIDES AND SOLID BASE**

M0605
M0611
M0612

## ABS DIVIDERS

Correspond to relevant tray heights.



**SHORT DIVIDER 400 D (mm)**

M0645
M0641
M0642



**LONG DIVIDER 600 D (mm)**

M0665
M0661
M0662



## COMPACT SIZE 400 x 300

ABS offers a tidy container solution, with a user temperature range of -20°C to +60°C resistant to standard detergents.

W (mm)	D (mm)	H (mm)
400	300	50
400	300	100
400	300	200



**OPEN SIDES AND SOLID BASE**

-
M0301
M0302



**OPEN SIDES AND OPEN BASE**

-
-
-



**SOLID SIDES AND SOLID BASE**

M0305
M0311
M0312

## ABS DIVIDERS

Correspond to relevant tray heights.



**SHORT DIVIDER 300 D (mm)**

M0635
M0631
M0632



**LONG DIVIDER 400 D (mm)**

M0645
M0641
M0642

# ANTI- STATIC TRAYS

Dissipates static charge build up preventing dust particles attaching to the trays and dividers.

An aid for your hygiene routine.

The same protective qualities throughout our Medstor container ranges.

- Load bearing capacity of 35kg
- Good impact strength
- Conform to international module sizes
- Full integration between trays and dividers
- Solid base options protect from fluid leaks
- Perforated base options improve air flow
- Inbuilt cabinet drawer stops
- Seamless hygienic design
- Nestable same size containers

*ACTIVELY WORKING TO REPEL STATIC BUILD UP...*



Temperature range -20°C to +60°C

#### LONG DIVIDERS

Slot into the tray wall to start configuration.

#### SHORT DIVIDERS

Sit into the long divider to create robust secured compartments.

#### SNAPPABLE DIVIDERS

Insert in any orientation to maximise tray configuration, support with T Clip.

#### LABEL HOLDERS

Portrait and landscape fitting see page 25 for all options.

#### T-CLIP

Used with snappable dividers to support open ends. Code F112.

# PRACTICAL APPLICATIONS

OUR MOST HYGIENIC TRAY WITH ANTI-STATIC POLYMER PROTECTION



Dissipates static charge build up preventing dust particles attaching to the trays and dividers.



An aid to your hygiene routine.



The same protective qualities throughout our Medstor container ranges.



## EURO SIZE 600 x 400

ABS-AS offers a tidy container solution, with a user temperature range of -20°C to +60°C resistant to standard detergents.

W (mm)	D (mm)	H (mm)
600	400	50
600	400	100
600	400	200



OPEN SIDES AND SOLID BASE

-
M0601AS
M0602AS



OPEN SIDES AND OPEN BASE

-
M0651AS
-



SOLID SIDES AND SOLID BASE

M0605AS
-
-

## ABS-AS DIVIDERS

Corresponds with relevant tray height.



SHORT DIVIDER 400 D (mm)

M0645AS
M0641AS
M0642AS



LONG DIVIDER 600 D (mm)

M0665AS
M0661AS
M0662AS



## EURO SIZE 400 x 300

ABS-AS offers a tidy container solution, with a user temperature range of -20°C to +60°C resistant to standard detergents.

W (mm)	D (mm)	H (mm)
400	300	50
400	300	100
400	300	200



OPEN SIDES AND SOLID BASE

-
M0301AS
M0302AS



OPEN SIDES AND OPEN BASE

-
-
-



SOLID SIDES AND SOLID BASE

M0305AS
M0311AS
-

## ABS-AS DIVIDERS

Corresponds with relevant tray height.



SHORT DIVIDER 300 D (mm)

M0635AS
M0631AS
M0632AS



LONG DIVIDER 400 D (mm)

M0645AS
M0641AS
M0642AS

# NEAT AND TIDY

## FULLY ADJUSTABLE TRAY COMPARTMENTS



Fully integrated dividers work with all tray types to create individual compartments to ensure product protection and segregation.

Dividers fit lengthways and widthways to accommodate the materials stored.

### SHORT DIVIDERS

Further segregation can be made by simply measuring and snapping off sections of the pre-scored dividers to re-configure any disorderly tray areas.

Polycarbonate, ABS and ABS-AS all interwork. Change the layout, configuration in seconds.



# NEAT AND TIDY

## ABS INSERT TRAYS

- Fit snugly into the Euro size 600 x 400 containers
- High impact resistant
- Aid multiple product picking
- Variable heights



70mm High ABS INSERT TRAY

Code	Width	Length	Height
M6677	55	535	70



97mm High ABS INSERT TRAY

Code	Width	Length	Height
M6688	112	270	97



# SIMPLE IDENTIFICATION

## LABEL HOLDERS – INSERTS AND CARRIERS



Credit card and half credit card size label holders can be fitted both portrait and landscape to the tray front and rims to give an easy no fuss labelling system.



Label holders fit onto the internal tray dividers and rims.



Label holders can support multiple level stock control systems, Kanban, FIFO, Scan and Go, Dual Bin, Top UP and can be combined with any hospital software material management system.



### FOR USE WITH

84 x 53 Full sized card labels

### 84 x 53 FULL SIZED CREDIT CARD LABEL HOLDERS

Identify products immediately and control stock levels with our simple labelling system.



#### ADJUSTABLE BACK CLIP SECTION

F202



#### IN BUILT EDGE CLIP

F103



#### LAMINATED FRONT PANEL CLIP

F100



#### RIM CARRIER FOR F202

F301



#### CREDIT CARD SIZE INSERTS

F107 full sized Coloured cards\*  
F110 light weight white and red only



### FOR USE WITH

60 x 40 Half sized card labels

### 60 x 40 HALF SIZED CREDIT CARD LABEL HOLDERS

Identify products immediately and control stock levels with our simple labelling system.



#### ADJUSTABLE BACK CLIP SECTION

F201



#### IN BUILT CLIP

F101



#### RIM CARRIER FOR F201

F301



#### HEAVY & MID WEIGHT HALF SIZED INSERTS

F111 (Red and White mid weight)  
F102 (Heavy duty white only)

- For additional technology based stock level control please see page 146
- \*Card colours: Red, Blue, Yellow, Emerald green, Deep blue, Lavender, Black, Orange and White

## WALL MOUNTED CARD READER PANELS

Fix anywhere board for a multiple scanning point.

- Full sized and half sized card options
- Simple to use- identification system
- Full integration for F2 series labels
- Effective materials management solution.

### LABEL CARD HOLDER 5mm Opal white acrylic

Code	Width	Depth	Height	Description
F0160	250	5	420	21 labels
F0170	327	5	420	28 labels
F0180	558	5	420	49 labels



# WHEELED LINER AND ARRESTER SYSTEM XTRAGLIDE

## SMOOTH EASY GLIDE WITH POSITIVE STOP FUNCTION

### HORIZONTAL & 25° ANGLED

Liner and arrester colours are highlighted for illustration purposes: Light Grey and White as standard

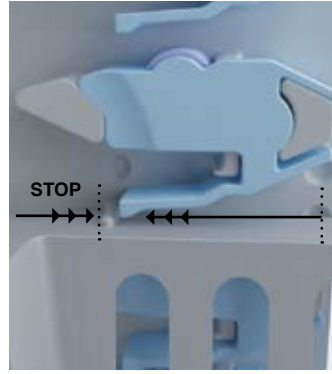
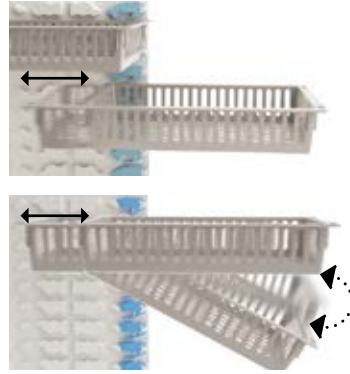
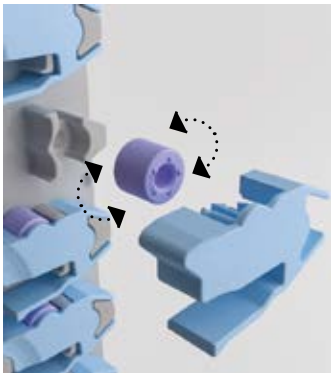

#### WHEELED LINER AND ARRESTER SYSTEM

With the Xtraglide free running wheel, fully loaded Medstor trays can be removed easily and quietly with the minimum of effort.

#### HORIZONTAL OR 25° ANGLED TRAYS

Xtraglide arresters can be fitted to the Medstor DUAL FIT liners to withdraw products in a horizontal or angled tray finished position.

#### POSITIVE STOP

When fully extended the tray is completely secured and product is easily accessible, a simple lift to override the positive arrest give complete tray removal.

#### Shhh...NOISE REDUCTION

Our new liner with wheeled arresters is so quiet, perfect to use close to any patient area.

VIEW OUR ONLINE DEMONSTRATION MOVIE:  
[www.medstor.co.uk/differentangles](http://www.medstor.co.uk/differentangles)

#### HORIZONTAL OR ANGLED TRAYS

Medstor liners with Xtraglide arresters tried and tested to hold weights up to 25.5 kg

Fitted on request to all Medstor HTM 71 Cabinets, Module Carts and Procedure Trolleys.

#### FITTED ON REQUEST TO HTM 71 SYSTEM PRODUCTS

Code	W (mm)	D (mm)	H (mm)	Description
M6669	650	x 26	x 390	High impact cabinet liner

#### ARRESTERS – SPECIFIED AT THE POINT OF ORDER

Code	W (mm)	L (mm)	H (mm)	Description
M7011	20	x 70	x 44	Wheeled left hand angled arrester
M7012	20	x 70	x 44	Wheeled right hand angled arrester
M7016	20	x 92	x 44	Wheeled left hand horizontal arrester
M7017	20	x 92	x 44	Wheeled right hand horizontal arrester
M7013	20	x 70	x 36	Wheeled left hand blank arrester
M7014	20	x 70	x 36	Wheeled right hand blank arrester
M7015				Wheel

All arresters push fit into place so no tool is required.  
 Arresters can be removed and repositioned giving system flexibility.

**PLEASE CONTACT MEDSTOR FOR ADDITIONAL INFORMATION OR TO SCHEDULE AN INFORMAL MEETING**

#### FORCE REQUIRED TO WITHDRAW LOADED TRAY

FORCE GAUGE RESULTS  
 2.5 - 25.5Kg LOADING WEIGHT(Kg)



● Wheeled arrester performance results:

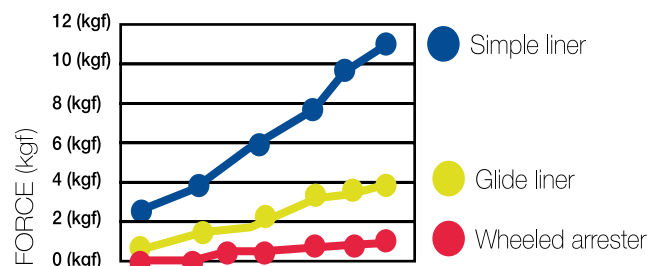

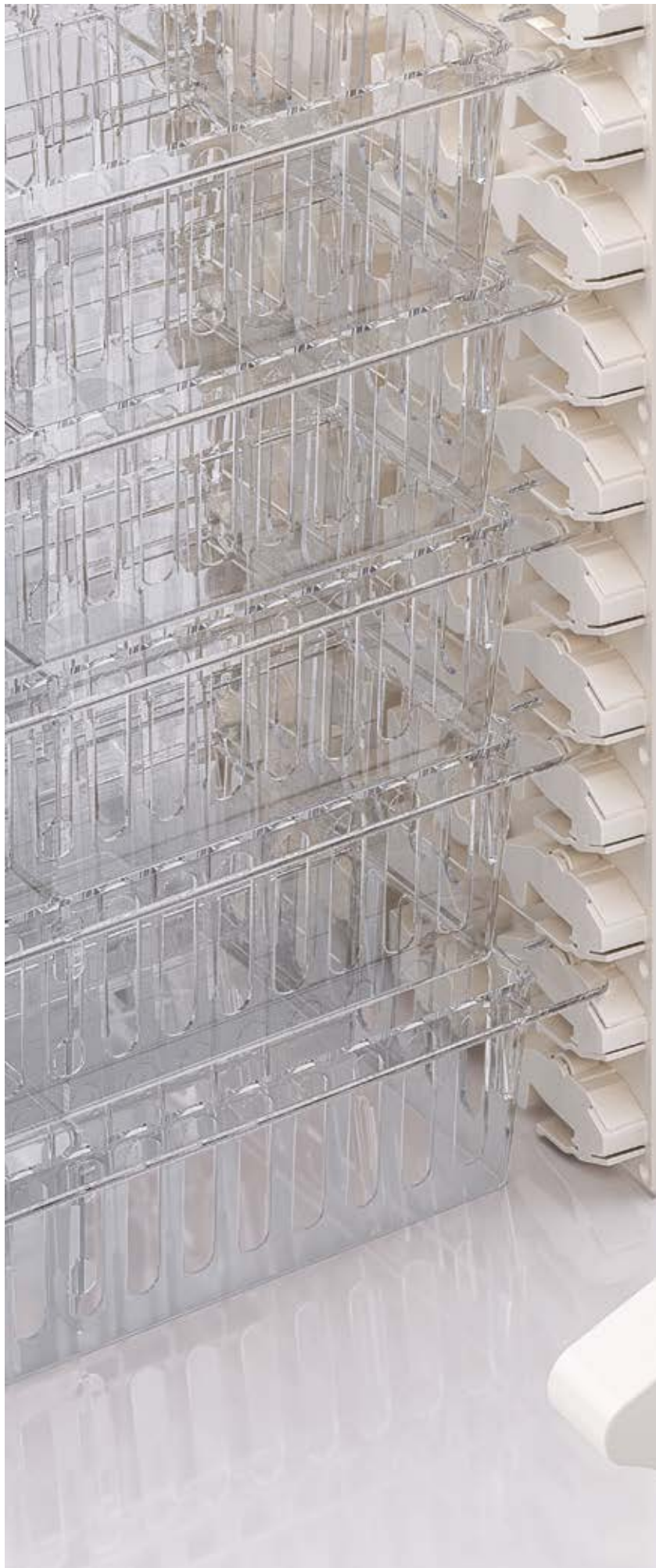

## WHY USE A WHEEL?

IT REDUCES THE FORCE NEEDED TO WITHDRAW HEAVY TRAYS...

THE SIMPLE WHEEL DESIGN REDUCES ANY PRESSURE FROM TRAY CONTENTS ONTO THE LINER CREATING A GLIDE EFFECT WITH EACH ROTATION OF THE WHEEL, THIS IN-TURN REDUCES BOTH FRICTION AND ANY NOISE ASSOCIATED WITH TRAY WITHDRAWAL.

TRAY HAND HELD LOADING FORCE TESTS SHOW THE REDUCTION AGAINST STANDARD ARRESTERS AND LINERS.



### 25° ANGLED ARRESTER:

Gives full access to high level trays



### HORIZONTAL ARRESTER:

Gives easy access and stability to lower level trays.

# ERGONOMIC LINER SYSTEM

NO TOOL, PUSH FIT, DUAL FUNCTION ARRESTERS

## HORIZONTAL AND 25° ANGLED

Liner and arresters colours are highlighted for illustration purposes: Light Grey and White as standard.

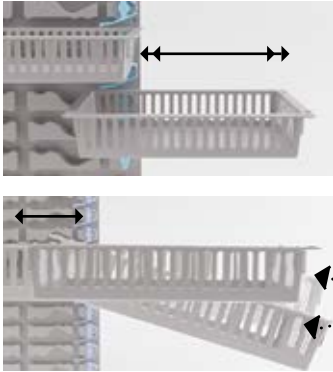

### LINER AND ARRESTER SYSTEM

The original positive stop with tilt arrester can be utilised to angle top trays at 25° for high level stock and to the base for horizontal tray withdrawal.

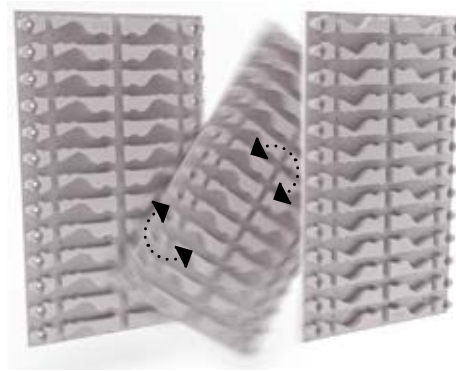

### CABINET LINER

Liners are rotated 180° to provide the option of angled or horizontal tray withdrawal in one high impact liner.

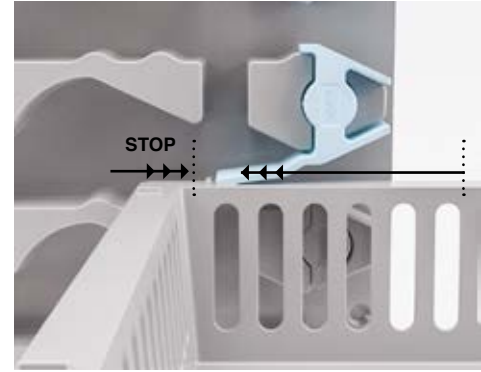

### POSITIVE STOP

Fully extended trays are fully supported providing access to tray contents.

HORIZONTAL OR 25° ANGLED TRAYS  
Medstor liners with push in arresters can support weights of up to 25.5 kgs.

### FITTED AS STANDARD TO ALL MEDSTOR HTM 71 CABINETS, MODULE CARTS AND PROCEDURE TROLLEYS

Code	W (mm)	D (mm)	H (mm)	Description
M6667	650	x 26	x 390	High impact cabinet liner

### ARRESTERS – SPECIFIED AT THE POINT OF ORDER

Code	W (mm)	L (mm)	H (mm)	Description
M6670	20	x 70	x 44	Left hand arrester
M6671	20	x 70	x 44	Right hand arrester
M6672	20	x 70	x 36	Blank clip

All arresters push fit into place no tool is required  
Arresters can be removed and repositioned giving system flexibility and hot washed increasing unit hygiene.

**PLEASE CONTACT MEDSTOR FOR ADDITIONAL INFORMATION OR TO SCHEDULE AN INFORMAL MEETING.**



# HIGH DENSITY LINER

MAXIMUM SPACE UTILISATION WITH FIXED ARRESTER

# HORIZONTAL RUNNER

Liner and arresters colours are highlighted for illustration purposes: Light Grey and White as standard.

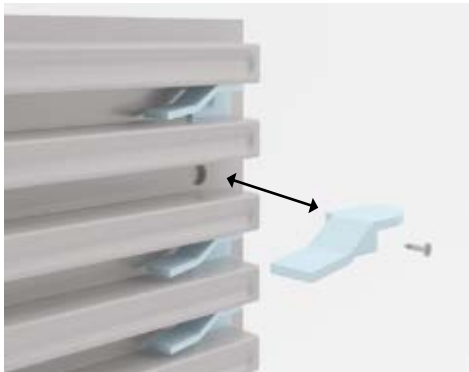

### LINER & ARRESTER SYSTEM

Smooth withdrawal of systems trays provides easy access to tray contents.

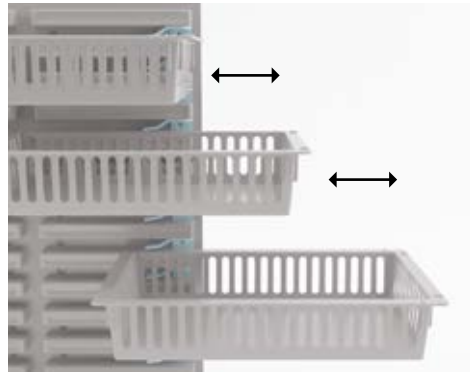

### HORIZONTAL LINER

Continual support holds trays straight and eliminates drop perfect for restrictive spaces.

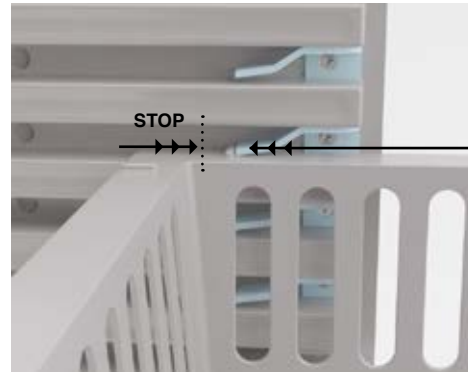

### FIXED ARRESTER

Medstor fixed arresters give a positive stop to eliminate accidental tray removal.

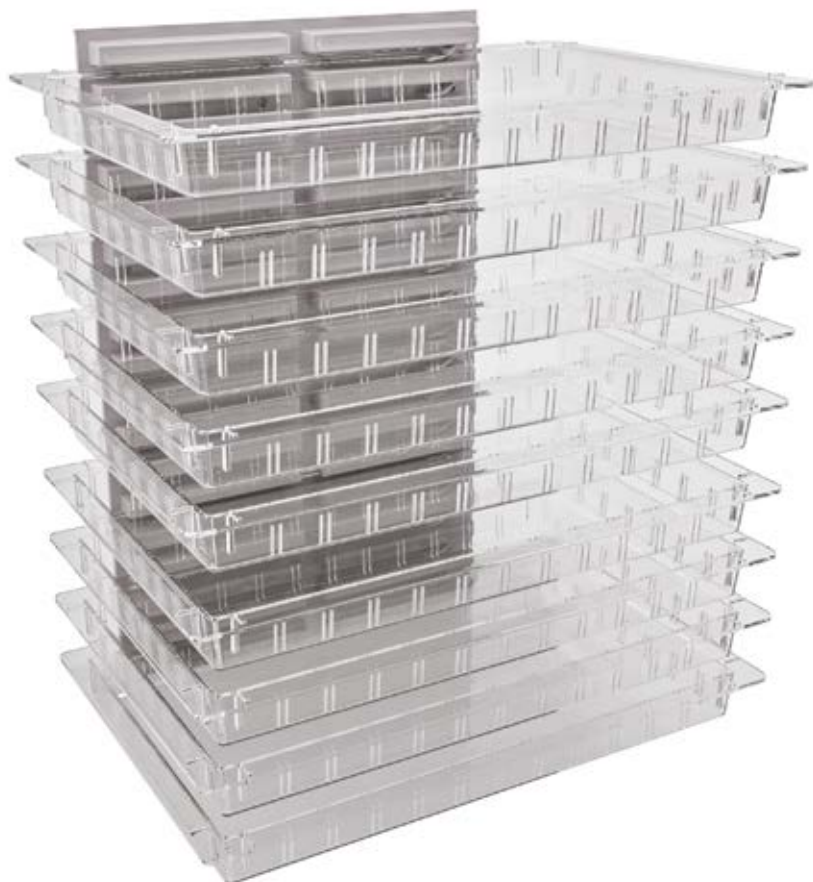

**HORIZONTAL TRAYS**  
Medstor liners with fixed arresters can support weights up to 35 kgs.

**FITTED ON REQUEST TO ALL MEDSTOR HTM 71 CABINETS, MODULE CARTS AND PROCEDURE TROLLEYS**

Code	W (mm)	D (mm)	H (mm)	Description
M6660	652	x 26	x 390	Horizontal cabinet liner

**ARRESTERS - SPECIFIED AT POINT OF ORDER**

Code	W (mm)	L (mm)	H (mm)	Description
M6662	20	x 70	x 44	Left hand arrester
M6663	20	x 70	x 44	Right hand arrester

Arresters are fixed into position via a screw fixing.

**RETROFIT FOR MULTI-USE**

Code	W (mm)	D (mm)	H (mm)	Description
M6664	20	x 92	x 44	Universal arrester clip

**PLEASE CONTACT MEDSTOR FOR ADDITIONAL INFORMATION OR TO SCHEDULE AN INFORMAL MEETING.**





# HTM 71 FURNITURE SYSTEM

## STORAGE UNITS

# BEST IN CLASS

Medstor HTM71, KANBAN, FIFO Healthcare Furniture.

Practical, stylish cabinets integrate with Medstor system liners and trays to create the perfect Healthcare working environment.

Seamlessly fitted to improve area hygiene.

ALL CABINETS ARE SUPPLIED COMPLETE WITH LINERS AND ARRESTERS.

# 2100 - 1700mm HTM 71 CABINETS

ELIMINATES STOCK OUTS - EASY LOCATION OF GOODS

- Practical and stylish cabinets, perfect for high volume storage needs and for organising supplies quickly.
- Cabinets are available free standing or wall fixed. Can be integrated as part of a fitted system.
- All cabinets interiors have Medstor liners fitted as standard.
- Available in various colour options with bespoke sizes available on request.
- A10 locks fitted as standard - for additional options see page 148.

**PLEASE CONTACT MEDSTOR FOR ADDITIONAL INFORMATION OR TO SCHEDULE AN INFORMAL MEETING.**

- Melamine, Laminate, Glass or Polycarbonate and roller shutter door styles are available.

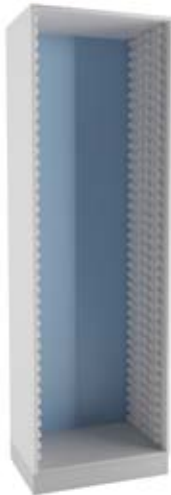

## CABINET: 2100mm

Code	Width	Depth
M6421	655	458
M4621	455	658

## LEFT HAND DOOR: 2100mm

Code	Width	Depth
M6421LH	655	476
M4621LH	455	676

## RIGHT HAND DOOR: 2100mm

Code	Width	Depth
M6421RH	655	476
M4621RH	455	676

## SPLIT DOORS: 2100mm

Code	Width	Depth
M6421SD	655	476
M4612SD	455	676

## CABINET: 1700mm

Code	Width	Depth
M6417	655	458
M4617	455	658

## LEFT HAND DOOR: 1700mm

Code	Width	Depth
M6417LH	655	476
M4617LH	455	676

## RIGHT HAND DOOR: 1700mm

Code	Width	Depth
M6417RH	655	476
M4617RH	455	676

## SPLIT DOORS: 1700mm

Code	Width	Depth
M6417SD	655	476
M4617SD	455	676



- Pharmacy cabinets are shown with warning light and drugs safe.
- Kaba security locks fitted as standard on pharmacy cabinets.
- Optional roll-out work surface.

## ROLLER SHUTTER: 2100mm

Code	Width	Depth
M7517RS	671	478
M5717RS	471	678

## ROLLER SHUTTER: 1700mm

Code	Width	Depth
M7517RS	671	478
M5717RS	471	678

## PHARMACY DOORS: 2100mm

Code	Width	Depth
M6421PD	655	476
M4621PD	455	676

## PHARMACY DOORS: 1700mm

Code	Width	Depth
M6417PD	655	458
M4617PD	455	658





**Bulkhead or Sloping top options:**  
Increase hygiene and reduce cleaning.

**Telescopic runners:**  
Extend the tray completely allowing easy removal, even when fully loaded. Please specify at point of order.

**A10 locks fitted as standard:**  
Electronic proximity and push button options are also available.



**Roller shutter doors:**

Sleek, quiet running, with compact coil mechanism and slatted polymer tambour door with front profile handle.

# 1200mm HTM 71 CABINETS

## 455 & 655 FACING FLEXIBLE STORAGE UNITS

- Fix to base cabinets to maximise storage potential.
- Optional plinth to create a free standing unit. Can be integrated as part of a fitted system.
- All cabinet interiors have Medstor liners fitted as standard.
- Available in various colour options with bespoke sizes available on request.
- A10 locks fitted as standard - for additional options see page 148.

**PLEASE CONTACT MEDSTOR FOR ADDITIONAL INFORMATION OR TO SCHEDULE AN INFORMAL MEETING.**

- Melamine, Laminate, Glass, Polycarbonate and Roller shutter door styles available



**CABINET: 1200mm**

Code	Width	Depth
M6412	655	458
M4612	455	658



**LEFT HAND DOOR: 1200mm**

Code	Width	Depth
M6412LH	655	476
M4612LH	455	676



**RIGHT HAND DOOR: 1200mm**

Code	Width	Depth
M6412RH	655	476
M4612RH	455	676



**SPLIT DOORS: 1200mm**

Code	Width	Depth
M6412SD	655	476
M4612SD	455	676



**LEFT HAND PHARMACY**

**DOOR: 1200mm**

Code	Width	Depth
M6412LHP	655	476
M4612LHP	455	676



**RIGHT HAND PHARMACY**

**DOOR: 1200mm**

Code	Width	Depth
M6412RHP	655	476
M4612RHP	455	676



**SPLIT PHARMACY**

**DOOR: 1200mm**

Code	Width	Depth
M6412SDP	655	476
M4612SDP	455	676



**ROLLER SHUTTER: 1200mm**

Code	Width	Depth
M7512RS	671	478
M5712RS	471	678

- Pharmacy cabinets are shown with warning light and drugs safe - Please see page 56.
- Kaba security locks fitted as standard on Pharmacy units.
- Optional Pharmacy pull out shelf - Please see page 42.

# 900, 870, & 860mm HTM 71 BASE CABINETS

EASY LOCATION OF GOODS, ELIMINATES STOCK OUTS

- Practical and stylish cabinets, perfect for high volume storage needs and for organising supplies quickly.
- Optional hygienic sealed telescopic drawer runners and Medstor system liners to suit.
- Cabinets are available free standing or wall fixed. Can be integrated as part of a fitted system.
- Available in various colour options with bespoke sizes available on request.
- A10 locks fitted as standard - for additional options see page 148.

**PLEASE CONTACT MEDSTOR FOR ADDITIONAL INFORMATION OR TO SCHEDULE AN INFORMAL MEETING.**

- Melamine, Laminate, Glass, Polycarbonate and Roller Shutter door styles available



**CABINET: 900mm**

Code	Width	Depth
M6409	655	458
M4609	455	658



**LEFT HAND DOOR: 900mm**

Code	Width	Depth
M6409LH	655	476
M4609LH	455	676



**RIGHT HAND DOOR: 900mm**

Code	Width	Depth
M6409RH	655	476
M4609RH	455	676



**SPLIT DOORS: 900mm**

Code	Width	Depth
M6409SD	655	476
M4609SD	455	676

**CABINET: 870mm**

Code	Width	Depth
M6487	655	458
M4687	455	658

**LEFT HAND DOOR: 870mm**

Code	Width	Depth
M6487LH	655	476
M4687LH	455	676

**RIGHT HAND DOOR: 870mm**

Code	Width	Depth
M6487RH	655	476
M4687RH	455	676

**SPLIT DOORS: 870mm**

Code	Width	Depth
M6487SD	655	476
M4687SD	455	676

**CABINET: 860mm**

Code	Width	Depth
M6486	655	458
M4686	455	658

**LEFT HAND DOOR: 860mm**

Code	Width	Depth
M6486LH	655	476
M4686LH	455	676

**RIGHT HAND DOOR: 860mm**

Code	Width	Depth
M6486RH	655	476
M4686RH	455	676

**SPLIT DOORS: 860mm**

Code	Width	Depth
M6486SD	655	476
M4686SD	455	676



**ROLLER SHUTTER DOOR: 900mm**

Code	Width	Depth
M7509RS	655	476
M5709RS	455	678

**ROLLER SHUTTER DOOR: 870mm**

Code	Width	Depth
M7587RS	655	476
M5787RS	455	678

**ROLLER SHUTTER DOOR: 860mm**

Code	Width	Depth
M7586RS	655	476
M5786RS	455	678



**A10 locks fitted as standard:**  
Electronic proximity and push button  
options are also available.

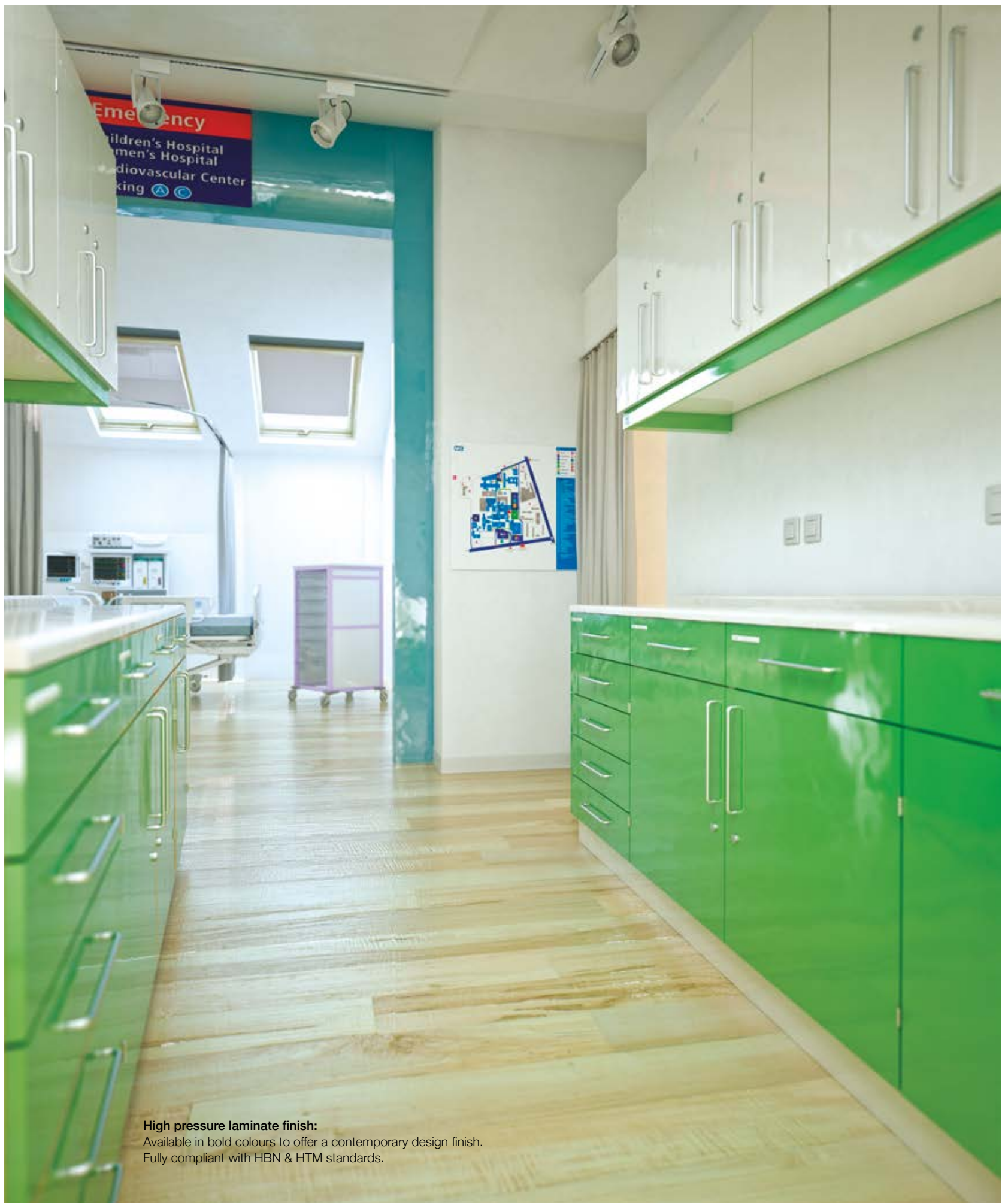

**High pressure laminate finish:**  
Available in bold colours to offer a contemporary design finish.  
Fully compliant with HBN & HTM standards.

# 900, 870, & 860mm HTM71 BASE CABINETS

EASY LOCATION OF GOODS, ELIMINATES STOCK OUTS

- Practical and stylish cabinets, perfect for high volume storage needs and for organising supplies quickly.
- Cabinets are complete with hygienic sealed telescopic drawer runners and Medstor system liners to suit.
- Cabinets are available free standing or wall fixed. Can be integrated as part of a fitted system.
- Available in various colour options with bespoke sizes available on request.
- A10 locks fitted as standard - for additional options see page 148.

**PLEASE CONTACT MEDSTOR FOR ADDITIONAL INFORMATION OR TO SCHEDULE AN INFORMAL MEETING.**

• Melamine, Laminate, Glass, Polycarbonate and Roller Shutter door styles available



**3 DRAWER: 900mm**

Code	Width	Depth
M6409D3	655	476
M4609D3	455	676



**5 DRAWER: 900mm**

Code	Width	Depth
M6409D5	655	476
M4609D5	455	676



**DRAWER & LEFT HAND DOOR: 900mm**

Code	Width	Depth
M6409DLH	655	476
M4609DLH	455	676



**DRAWER & RIGHT HAND DOOR: 900mm**

Code	Width	Depth
M6409DRH	655	476
M4609DRH	455	676

**3 DRAWER: 870mm**

Code	Width	Depth
M6487D3	655	476
M4687D3	455	676

**5 DRAWER: 870mm**

Code	Width	Depth
M6487D5	655	476
M4687D5	455	676

**DRAWER & LEFT HAND DOOR: 870mm**

Code	Width	Depth
M6487DLH	655	476
M4687DLH	455	676

**DRAWER & RIGHT HAND DOOR: 870mm**

Code	Width	Depth
M6487DRH	655	476
M4687DRH	455	676

**3 DRAWER: 860mm**

Code	Width	Depth
M6486D3	655	476
M4686D3	455	676

**5 DRAWER: 860mm**

Code	Width	Depth
M6486D5	655	476
M4686D5	455	676

**DRAWER & LEFT HAND DOOR: 860mm**

Code	Width	Depth
M6486DLH	655	476
M4686DLH	455	676

**DRAWER & RIGHT HAND DOOR: 860mm**

Code	Width	Depth
M6486DRH	655	476
M4686DRH	455	676



**DRAWER & SPLIT DOOR: 900mm**

Code	Width	Depth
M6409DSD	655	476
M4609DSD	455	676

**DRAWER & SPLIT DOOR: 870mm**

Code	Width	Depth
M6487DSD	655	476
M4687DSD	455	676

**DRAWER & SPLIT DOOR: 860mm**

Code	Width	Depth
M6486DSD	655	476
M4686DSD	455	676

**HTM 71 Drawer compartments:**

Fitted with system hygienic sealed telescopic runners to house Medstor tray system.



**High pressure laminate doors:**

Available in bold colours to offer a contemporary design finish.

**Polycarbonate doors:**

Clear shatterproof doors offer 100% visibility.



**Security - A10 locks:**

Used extensively across healthcare storage.

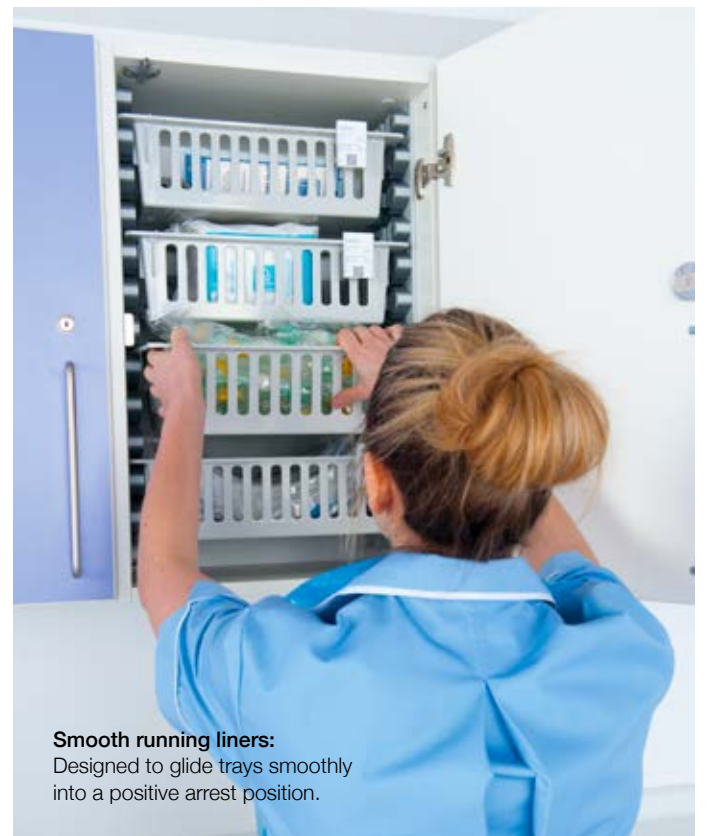

**Smooth running liners:**

Designed to glide trays smoothly into a positive arrest position.



# 750, 700 & 650mm HTM71 WALL CABINETS FOR EURO AND COMPACT TRAYS

EASY LOCATION OF GOODS, ELIMINATES STOCK OUTS

- Ergonomic solutions with the highest level of organisation.
- Designed for 600 x 400 Euro trays and 300 x 400 Compact trays.
- Cabinets are available for wall fixing.
- All cabinets have Medstor liners and arresters fitted as standard.
- Available in various colour options with bespoke sizes available on request.
- A10 locks fitted as standard - for additional options see page 148.

**PLEASE CONTACT MEDSTOR FOR ADDITIONAL INFORMATION OR TO SCHEDULE AN INFORMAL MEETING.**

- Melamine, Laminate, Glass, Polycarbonate and Roller Shutter door styles available



## CABINET: 750mm

Code	Width	Depth
M3675	655	376
M3475	455	376



## LEFT HAND DOOR: 750mm

Code	Width	Depth
M3675LH	655	394
M3475LH	455	394



## RIGHT HAND DOOR: 750mm

Code	Width	Depth
M3675RH	655	394
M3475RH	455	394



## SPLIT DOORS: 750mm

Code	Width	Depth
M3675SD	655	394
M3475SD	455	394

## CABINET: 700mm

Code	Width	Depth
M3670	655	376
M3470	455	376

## LEFT HAND DOOR: 700mm

Code	Width	Depth
M3670LH	655	394
M3470LH	455	394

## RIGHT HAND DOOR: 700mm

Code	Width	Depth
M3670RH	655	394
M3470RH	455	394

## SPLIT DOORS: 700mm

Code	Width	Depth
M3670SD	655	394
M3470SD	455	394

## CABINET: 650mm

Code	Width	Depth
M3665	655	376
M3465	455	376

## LEFT HAND DOOR: 650mm

Code	Width	Depth
M3665LH	655	394
M3465LH	455	394

## RIGHT HAND DOOR: 650mm

Code	Width	Depth
M3665RH	655	394
M3465RH	455	394

## SPLIT DOORS: 650mm

Code	Width	Depth
M3665SD	655	394
M3465SD	455	394



### DOOR OPTIONS:

All cabinets can be fitted in Melamine, Laminate, Glass, Polycarbonate and Roller Shutter door styles.

# 750, 700 & 650mm HTM 71 WALL CABINETS

EASY LOCATION OF GOODS – ELIMINATES STOCK OUTS

- Ergonomic solutions with the highest level of organisation.
- Designed for 600x 400 Euro trays and 300 x 400 Compact trays.
- Cabinets are available for wall fixing.
- All cabinets have Medstor liners and arresters fitted as standard.
- Available in various colour options with bespoke sizes available on request.
- A10 locks fitted as standard - for additional options see page 148.

**PLEASE CONTACT MEDSTOR FOR ADDITIONAL INFORMATION OR TO SCHEDULE AN INFORMAL MEETING.**

- Melamine, Laminate, Glass, Polycarbonate and Roller Shutter door styles available



## ROLLER SHUTTER: 750mm

Code	Width	Depth
M3675RS	671	396
M3475RS	471	396

## LEFT HAND PHARMACY DOOR: 750mm

Code	Width	Depth
M3675LHP	655	394
M3475LHP	455	394

## RIGHT HAND PHARMACY DOOR: 750mm

Code	Width	Depth
M3675RHP	655	394
M3475RHP	455	394

## SPLIT PHARMACY DOORS: 750mm

Code	Width	Depth
M3675SDP	655	394
M3475SDP	455	394

## ROLLER SHUTTER: 700mm

Code	Width	Depth
M3670RS	671	396
M3470RS	471	396

## LEFT HAND PHARMACY DOOR: 700mm

Code	Width	Depth
M3670LHP	655	394
M3470LHP	455	394

## RIGHT HAND PHARMACY DOOR: 700mm

Code	Width	Depth
M3670RHP	655	394
M3470RHP	455	394

## SPLIT PHARMACY DOORS: 700mm

Code	Width	Depth
M3670SDP	655	394
M3470SDP	455	394

## ROLLER SHUTTER: 650mm

Code	Width	Depth
M3665RS	671	396
M3465RS	471	396

## LEFT HAND PHARMACY DOOR: 650mm

<b>M3665LHP655</b>	<b>394</b>	
M3665LHP	655	394
M3465LHP	455	394

## RIGHT HAND PHARMACY DOOR: 650mm

Code	Width	Depth
M3665RHP	655	394
M3465RHP	455	394

## SPLIT PHARMACY DOORS: 650mm

Code	Width	Depth
M3665SDP	655	394
M3465SDP	455	394

- Pharmacy cabinets are shown with warning light and drugs safe - Please see page 56.
- Kaba security locks fitted as standard to all Pharmacy units.



**OPTIONAL PULL OUT SHELF:**  
Sturdy retractable shelf, designed as a temporary surface extension for Pharmacy wall fixed cabinets.

**Bulkhead or Sloping top:**  
Option available for all wall cabinets.

**Hazard flashing warning lights:**  
Available for Controlled Drugs Units.

**High security:**  
Kaba locks fitted to all medicine cabinets.





**Functional storage:**  
Under cabinet storage drawer to  
maximise your workspace.

# 750, 700 & 650mm HTM 71 WALL CABINETS

## 45° DROP DOWN DRAWER UNIT

- Ergonomic solutions with the highest level of organisation.
- Drop down drawer load capacity of 2.5kg.
- Designed for 300 x 400 Compact trays.
- Cabinets are available for wall fixing.
- All cabinets have Medstor liners and arresters fitted as standard.
- Available in various colour options with bespoke sizes available on request.
- A10 locks fitted as standard - for additional options see page 148.

**PLEASE CONTACT MEDSTOR FOR ADDITIONAL INFORMATION OR TO SCHEDULE AN INFORMAL MEETING.**

- Melamine, Laminate, Glass, Polycarbonate and Roller Shutter door styles available.

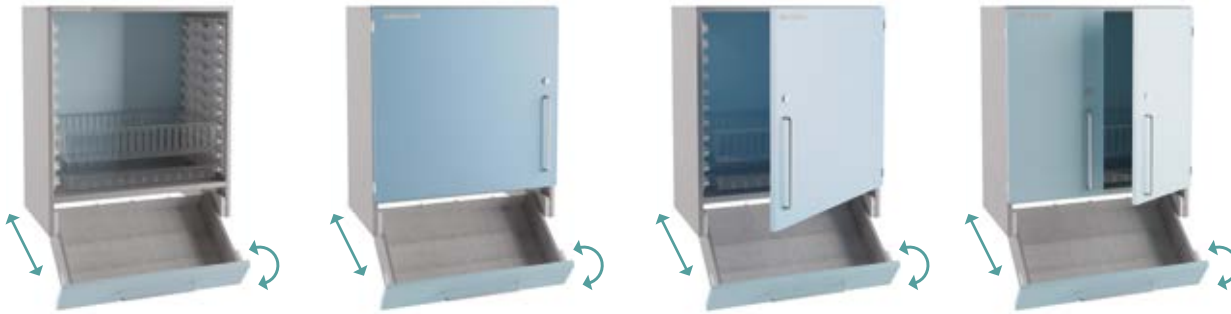

### CABINET: 750mm

Code	Width	Depth
M3675DD	655	376
M3475DD	655	376

### LEFT HAND DOOR: 750mm

Code	Width	Depth
M3675LDD	655	394
M3475LDD	455	394

### RIGHT HAND DOOR: 750mm

Code	Width	Depth
M3675RDD	655	394
M3475RDD	455	394

### SPLIT DOORS: 750mm

Code	Width	Depth
M3675SDD	655	394
M3475SDD	455	394

### CABINET: 700mm

Code	Width	Depth
M3670DD	655	376
M3470DD	455	376

### LEFT HAND DOOR: 700mm

Code	Width	Depth
M3670LDD	655	394
M3470LDD	455	394

### RIGHT HAND DOOR: 700mm

Code	Width	Depth
M3670RDD	655	394
M3470RDD	455	394

### SPLIT DOORS: 700mm

Code	Width	Depth
M3670SDD	655	394
M3470SDD	455	394

### CABINET: 650mm

Code	Width	Depth
M3665DD	655	376
M3465DD	455	376

### LEFT HAND DOOR: 650mm

Code	Width	Depth
M3665LDD	655	394
M3465LDD	455	394

### RIGHT HAND DOOR: 650mm

Code	Width	Depth
M3665RDD	655	394
M3465RDD	455	394

### SPLIT DOORS: 650mm

Code	Width	Depth
M3665SDD	655	394
M3465SDD	455	394

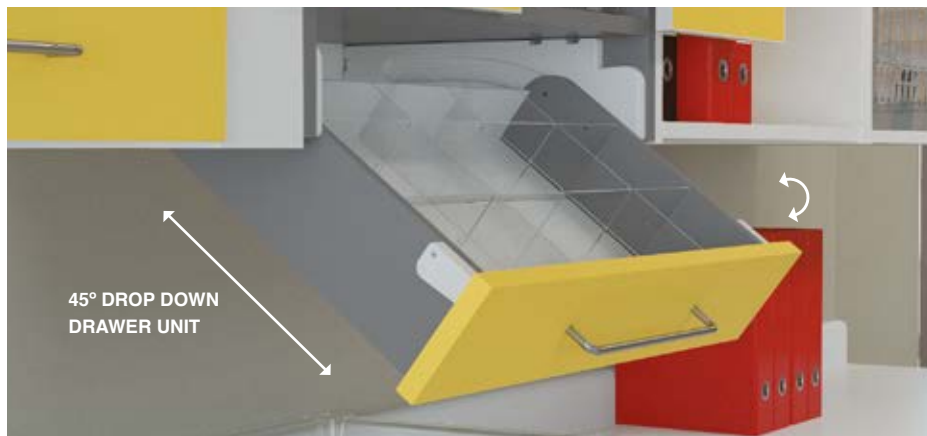

45° DROP DOWN  
DRAWER UNIT



### SLIDE AND TILT:

The robust bracket system tapers the drawer action ensuring a smooth lowering of the drawer from the cabinet.

### PHARMACY AND MEDICINE CABINETS:

Security locking top section with fast access drawer (non locking). Optional M4494 hazard warning beacon and M4493 micro switch.

# HTM COMPLIANT WORKTOPS

LAMINATE – SOLID SURFACE – SOLID CORE – STAINLESS STEEL

- Providing clean functional working environments fit for purpose.
- Slimline profile to increase system storage capacity.
- Worktops can be integrated as part of a fitted system, double post formed with integral 50mm upstand and front bullnosing.
- Moisture resistant MDF base as standard.
- Chemical resistant – Laboratory surfaces with full test certification.
- Available in various colour options with bespoke sizes available on request.

FREE DESIGN AND SPECIFICATION SERVICES FOR ALL MEDSTOR SYSTEMS.

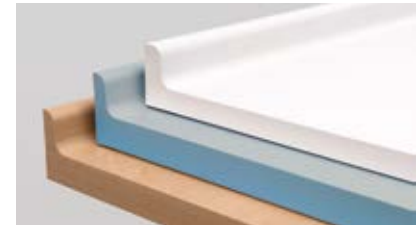

Worktops available with plant on upstands or fully integrated 50mm upstand for an improved hygienic finish.



## LAMINATE WORKTOP

### Properties

- Versatile, robust and hygienic surface.
- High resistance to external stress (abrasion, impacts and stains).
- Silver ion treated antibacterial Sanitized® grades available.
- Non porous waterproof surface.
- Food safe (IANESCO approved).

### Applications

- Suitable for high traffic healthcare environments.
- Covering wall panels as well as horizontal worktops and furniture.
- Can be cold bent or postformed for curved surfaces.

## SOLID SURFACE WORKTOPS

### Properties

- Easy to clean and maintain. When properly cleaned does not support the growth of bacteria.
- Seam free sink units and jointing.
- Full colour and pigment options.
- Creative finishing available.
- Life time warranty.
- Solid surface worktops can be re-worked again and again.

### Applications

- All healthcare environments
- Withstands frequent contact with patient beds, wheelchairs and medical equipment.
- Surfaces resist common stains such as blood, betadine and Gentian's violet.
- Easy to achieve an aesthetically pleasing design that gives patients confidence in cleanliness and attention to their care.
- Vibrant colours to help stimulate early childhood development in neonatal and paediatric areas.

## RESIN CORE WORKTOPS

### Properties

- Suitable for chemical resistance in healthcare environments.
- Durable solid surfaces are made of all-acrylic material are very durable and long lasting.
- NSF Compliant because of their hygienic qualities. One of the few surfaces certified safe for direct contact with food.
- Counter tops look immaculate, just wipe with a damp cloth or sponge. Food residue can be easily removed with a mild detergent or glass cleaner.

### Applications

- Solid surfaces can be custom- fabricated.
- Unlike other surface options, solid surfaces do not need to be replaced if a scratch, chip or crack appears. Scratches can be easily sanded out, leaving the counter top fully restored.

**Depths:**

Standard post formed HTM 71 worktops are available in 500mm, 600mm, 700mm and 800mm depths.

**Thickness:**

28mm or 38mm as standard, other sizes available to order: Contact our sales office for more details.

**Lengths:**

Up to 3000mm available without joints as standard.

**ALL WORKTOP SIZES CAN BE CUSTOM PRODUCED TO FIT YOUR EXACT REQUIREMENTS.**



# HTM 71 COMPLIANT DOORS

## CONCEALED CONTENT STORAGE

- Providing clean functional working environments for a heightened hygienic solution.
- Doors can be integrated as part of a fitted system.
- Available in Melamine, Laminate, Glass, Polycarbonate and Roller Shutter styles as standard.
- Sleek system hinges allow the optimal opening for ease of tray withdrawal.
- Designed to take multiple locking options.
- Supplied as standard with locks, handles and soft closure system.
- Edged as standard in a robust 2mm Abs edging for longevity of performance.

**FREE DESIGN AND SPECIFICATION SERVICES FOR ALL MEDSTOR SYSTEMS.**



**HTM 71 UNIT HINGE**



**HTM 63 UNIT HINGE**

Cabinet hinges are securely fitted for high volume areas.

### MELAMINE

#### Properties

- Environmentally friendly.
- Versatile and robust hygienic finish.
- Available from stock in grey and white.
- Edged in contrasting/matching 2mm ABS edging.

#### Applications

- Suitable for high traffic healthcare environments.

### LAMINATE

#### Properties

- Versatile, robust and hygienic surface.
- High resistance to external stress (abrasion, impacts and stains).
- Silver ion treated antibacterial Sanitized® grades available.
- Non porous waterproof surface.
- Food safe (IANESCO approved).
- Can be cold bent or postformed for curved surfaces.

#### Applications

- Suitable for high traffic healthcare environments.
- Covering wall panels as well as horizontal worktops and furniture.

### WCB Waterproof Construction Board

#### Properties

- Manufactured as one homogeneous piece.
- No possibility of delamination.
- Foam closed cell core, solid and aesthetically captivating PVC surface.
- Pore-free surface is totally impervious to all liquids.
- Tough and impact resistant.
- DIN 4102 with B1 Test Certificate – Class B1 - Low flammability.

#### Medical use

Pore-free surface is totally impervious to all liquids, such as radio-isotopes, human tissue, blood samples, bacteria, molds or micro-organisms, bleaches and cleaning agents.



# HTM COMPLIANT DOORS

## CONCEALED AND VISIBLE CONTENT STORAGE



All cabinets are fitted with A10 lock as standard.  
For additional security options please see page 148.



### ROLLER SHUTTER TAMBOUR DOORS

#### Properties

- Sleek quiet running with compact coil mechanism.
- Slatted polymer tambour door.
- Integral front profile handle.
- Available with locking options

#### Applications

- Suitable for all healthcare environments.
- Perfect for restricted spaces.



### GLASS DOORS

#### Properties

- 6mm toughened glass BS standard.
- 100% visibility.
- Smooth radius edges.
- Scratch resistant.
- Available with full locking options.

#### Applications

Suitable for healthcare environments where immediate product location is crucial.



### POLYCARBONATE DOORS

#### Properties

- 100% visibility shatterproof solution.
- Versatile and robust hygienic finish.
- Available with full locking options.
- Magnetic top catch.

#### Applications

Suitable for healthcare environments where immediate product location is crucial.  
All healthcare heavy traffic areas.

# ACCESSORIES

## TAPS – SINK UNITS – HANDLES

- Medstor accessories comply with all current HTM specifications.
- Taps HTM64/HBN 00-10 Part C Sanitary Assemblies compliant.
- Waste HTM64/HBN 00-10 Part C Sanitary Assemblies compliant.
- Sinks HTM 64/HBN 00-10 Part C Compliant.
- All accessories can be integrated as part of a fitted system.

**FREE DESIGN AND SPECIFICATION SERVICES FOR ALL MEDSTOR SYSTEMS**



### TAPS AND FILTERS

#### TAPS HTM64/HBN 00-10 Part C Sanitary Assemblies

We only supply taps in line with current standards.  
Taps specified as per HBN 00-10 specific to the area requirement.  
Pillar sets, Bib Mixers, Panel Mixer sets, and Sensors.

#### Filter technology

New innovative tap filters provide sterilised grade water, tested in UK laboratory under clean water conditions.



### SINK BOWL UNITS

#### HTM64/HBN 00-10 Part C Sanitary Assemblies

- We only supply sinks in line with current standards.
- Sinks are specified as per HBN 00-10 specific to the area requirement.
- Off set drainage, no plugs, stainless steel with and without drainers.

**Please refer to Bluebook for full current product listings.**



### HANDLE TYPES

#### HTM 71 and 63 Styles

- System handles are easy clean with a choice in design.
- Contemporary sleek brushed aluminium finish square edged .
- Smooth-line ergonomic 'D' design round edges.
- Handles are reverse mounted for a flush hygienic fit.

#### Anti-ligature handles

- Bolt through, flush pull handles in aluminium and stainless steel.
- Box section curved to prevent objects being forced into the slot.
- Fitted with tamper evident screws.

# ACCESSORIES

## SLOPING TOPS – BULK HEADS – PELMETS – CABLE MANAGEMENT

- Providing clean functional working environments fit for purpose.
- Accessories integrated as part of a fitted system.

FREE DESIGN AND SPECIFICATION SERVICES FOR ALL MEDSTOR SYSTEMS



### CABINET TOPS

#### Angled sloping tops

- Hygienic angled top surface - reduces cleaning time.
- 455mm and 655mm wide extended run depths.
- Fits directly to cabinet top panel.

#### Bulkhead tops

- Prevents any dust collection to the cabinet tops.
- Extends cabinet panels to interior ceiling level.
- Bespoke sizes to fit all room shapes.
- Hides any electrical cabling or utilities.
- Colour coordinated or feature panel designs.



### UNDER CABINET PELMETS

- Secured directly to the wall mounted cabinets.
- Discreet lighting cover.
- Optional heights available.
- Selection of colour options.



### CABLE MANAGEMENT

We have a number of cable management products available:

- PVC trunking.
- Cable trunking.
- Cable clips and organisers.
- Flexible conduit.

# SPECIALIST CABINETS

MEDICINE - DRUGS - CATHETER & SCOPES

## CONCEPT TO CREATION

We provide safe and secure ways of handling medicines to the standards set by the Royal Pharmaceutical Society.

Our cabinets offer space optimisation with high level security features.

ALL OUR UNITS ARE FITTED WITH SECURITY LOCKS...





# MOBILE CABINETS

900, 1330, 1800 & 1950mm HIGH

- High volume storage utilising liners, trays and dividers for supplies.
- Cabinets are fitted with non marking castors and brakes.
- Mobile cabinets are BS 4875-8 certified for stability.
- Available in various colour options with bespoke sizes available on request.

**PLEASE CONTACT MEDSTOR FOR ADDITIONAL INFORMATION OR TO SCHEDULE AN INFORMAL MEETING.**

- Melamine, Laminate, Glass, Polycarbonate and Roller Shutter door styles available.



Mobile cabinets to help create a flexible healthcare environment.



**CABINET: 1950mm**

Code	Width	Depth
H6419M	658	524
H4619M	524	658



**LEFT HAND DOOR: 1950mm**

Code	Width	Depth
H6419LHM	658	524
H4619LHM	524	676



**RIGHT HAND DOOR: 1950mm**

Code	Width	Depth
H6419RHM	658	524
H4619RHM	524	676



**SPLIT DOORS: 1950mm**

Code	Width	Depth
H6419SDM	658	524
H4619SDM	524	676



**ROLLER SHUTTER DOORS: 1950mm**

Code	Width	Depth
H7519RSM	681	537
H5719RSM	537	681

**CABINET: 1800mm**

Code	Width	Depth
H6418M	658	524
H4618M	524	658

**LEFT HAND DOOR: 1800mm**

Code	Width	Depth
H6418LHM	658	524
H4618LHM	524	676

**RIGHT HAND DOOR: 1800mm**

Code	Width	Depth
H6418RHM	658	524
H4618RHM	524	676

**SPLIT DOORS: 1800mm**

Code	Width	Depth
H6418SDM	658	524
H4618SDM	524	676

**ROLLER SHUTTER DOORS: 1800mm**

Code	Width	Depth
H7518RSM	681	537
H5718RSM	537	681

**CABINET: 1330mm**

Code	Width	Depth
H6413M	658	458
H4613M	458	658

**LEFT HAND DOOR: 1330mm**

Code	Width	Depth
H6413LHM	658	476
H4613LHM	458	676

**RIGHT HAND DOOR: 1330mm**

Code	Width	Depth
H6413RHM	658	476
H4613RHM	458	676

**SPLIT DOORS: 1330mm**

Code	Width	Depth
H6413SDM	658	476
H4613SDM	458	676

**ROLLER SHUTTER DOORS: 1330mm**

Code	Width	Depth
H7513RSM	681	481
H5713RSM	481	681

**CABINET: 900mm**

Code	Width	Depth
H6409M	658	458
H4609M	458	658

**LEFT HAND DOOR: 900mm**

Code	Width	Depth
H6409LHM	658	476
H4609LHM	458	676

**RIGHT HAND DOOR: 900mm**

Code	Width	Depth
H6409RHM	658	476
H4609RHM	458	676

**SPLIT DOORS: 900mm**

Code	Width	Depth
H6409SDM	658	476
H4609SDM	458	676

**ROLLER SHUTTER DOORS: 900mm**

Code	Width	Depth
H7509RSM	681	481
H5709RSM	481	681



Double units offer additional capacity to mobile cabinet unit.

## DOUBLE MOBILE CABINETS

900, 1330, 1800 & 1950mm HIGH



**DOUBLE CABINET: 1950mm**

Code	Width	Depth
H6419MD	1313	524
H4619MD	913	658



**DOUBLE DOOR: 1950mm**

Code	Width	Depth
H6419LHMD	1313	524
H4619LHMD	913	676



**DOUBLE SPLIT DOORS: 1950mm**

Code	Width	Depth
H6419SDMD	1313	524
H4619SDMD	913	676



**DOUBLE ROLLER SHUTTER DOORS: 1950mm**

Code	Width	Depth
H7519RSMD	1345	537
H5719RSMD	945	681

**CABINET: 1800mm**

Code	Width	Depth
H6418MD	1313	524
H4618MD	913	658

**DOUBLE DOOR: 1800mm**

Code	Width	Depth
H6418LHMD	1313	524
H4618LHMD	913	676

**DOUBLE SPLIT DOORS: 1800mm**

Code	Width	Depth
H6418SDMD	1313	524
H4618SDMD	913	676

**DOUBLE ROLLER SHUTTER DOORS: 1800mm**

Code	Width	Depth
H7518RSMD	1345	537
H5718RSMD	945	681

**CABINET: 1330mm**

Code	Width	Depth
H6413MD	1313	524
H4613MD	913	658

**DOUBLE DOOR: 1330mm**

Code	Width	Depth
H6413LHMD	1313	524
H4613LHMD	913	676

**DOUBLE SPLIT DOORS: 1330mm**

Code	Width	Depth
H6413SDMD	1313	524
H4613SDMD	913	676

**DOUBLE ROLLER SHUTTER DOORS: 1330mm**

Code	Width	Depth
H7513RSMD	1345	537
H5713RSMD	945	681

**CABINET: 900mm**

Code	Width	Depth
H6409MD	1313	524
H4609MD	913	658

**DOUBLE DOOR: 900mm**

Code	Width	Depth
H6409LHMD	1313	524
H4609LHMD	913	676

**DOUBLE SPLIT DOORS: 900mm**

Code	Width	Depth
H6409SDMD	1313	524
H4609SDMD	913	676

**DOUBLE ROLLER SHUTTER DOORS: 900mm**

Code	Width	Depth
H7509RSMD	1345	537
H5709RSMD	945	681

# CONTROLLED DRUGS - INTERNAL CABINETS

## SAFE & SECURE STORAGE UNITS

- Drug Cabinets listed meet the requirements of BS2881:1989 and the locks specified meet the requirements of BS3621:2007 + A2:2012.
- Wall mounted - incorporating a 7 lever lock.
- Combine internally with HTM 71 cupboard units.
- Bespoke sizes available on request.

### INNER CONTROLLED DRUGS CABINETS

Code	W (mm)	D (mm)	H (mm)	Shelves
B2400	500	x 300	x 600	2
B1600	330	x 180	x 450	1
B1500	260	x 220	x 270	1
B1200	300	x 240	x 350	1
B1000	335	x 160	x 350	1



### SAFEGUARD

Various sizes are available to fit into our standard cabinets or bespoke versions can be manufactured to fit into existing cabinets.

### DRUGS CABINET BEACON WARNING LIGHT

Code	Dia (mm)	Height (mm)	Description
M4494	85	x 81	Surface mounted red flashing LED



### SAFEGUARD

Pharmacy cabinets are fitted with a micro switch that can either be connected to a fixed cabinet hazard warning light or wired directly to the Nursing stations.



# PHARMACY CABINETS

## CONTROLLED DRUGS

Drug Cabinets listed meet the requirements of BS2881:1989 and the locks specified meet the requirements of BS3621:2007 + A2:2012.

### FULL HEIGHT CONTROLLED DRUGS CABINETS

Code	W (mm)	D (mm)	H (mm)	Shelves	Doors
B2400	500	300	600	2	1
B2600	600	300	600	2	1
B2900	900	300	600	6	2
B2136	1000	300	600	4	2
B2141	1000	460	1800	12	2
B2500	500	300	900	3	1
B2639	600	300	900	3	1
B2139	1000	300	900	6	2

### ACCESSORIES

Door pockets, internal light and external warning light available on request.



#### SWIPE CARD LOCKING

Swipe card locking, contact sales office for further details.



B3002

# PHARMACY LOW CABINETS

## SAFE AND SECURE HANDLING

- Integral system liners and telescopic runners to fit Medstor trays.
- Units can be wall fixed.
- Drug Cabinets listed meet the requirements of BS2881:1989 and the locks specified meet the requirements of BS3621:2007 + A2:2012.

### BS2881 - HIGH DENSITY PHARMACY CABINETS

Code	W (mm)	D (mm)	H (mm)
B3001	790	455	900
B3002	790	455	900
B6001	790	455	900
B6002	790	455	900



B6002



B3001



B6001

Catheter Conversion Kits fit into all Medstor Cabinet Liners.



#### TELESCOPIC CARDIAC CATHETER RAIL

Side hanging rail extractable by up to 500mm.



#### CATHETER FORWARD AND SIDE HANGING RAILS

400 or 600mm chrome plated wire with secure door section fittings.



#### PULL OUT CATHETER BASKET

Chrome plated wire basket fitted on cabinet runners.

## HTM 71 URINARY AND CARDIAC CATHETER CABINETS

### CATHETER CONVERSION KITS

- Catheter Conversion Kits fit into all Medstor Cabinet Liners.
- Pull out forward hanging rails for both Urinary and Cardiac catheters.
- Pull out side hanging catheter rails for both Urinary and Cardiac catheters.

#### CONVERSION KITS

Code	Description	Used with	Type	Rails
M6400	Forward Hanging	600 shelf	Urinary	5 rails
M6401	Side hanging	600 shelf	Urinary	3 rails with hooks
M6402	Forward hanging	600 shelf	Cardiac	3 rails
M4600	Forward hanging	400 shelf	Urinary	3 rails
M4601	Side hanging	400 shelf	Urinary	2 rails with hooks
M4602	Forward hanging	400 shelf	Cardiac	2 rails

#### PULL OUT CATHETER BASKETS

Code	W (mm)	D (mm)	H (mm)
M3004	600 x	400 x	400
M3006	600 x	400 x	600
M3008	600 x	400 x	800
M3009	600 x	400 x	900

#### TELESCOPIC SIDE HANGING CARDIAC CATHETER RAIL

Code	W (mm)	D (mm)	H (mm)
M4600T	400 x	600 x	100

#### ACCESSORIES

Code	Description
M6402P	Swivel peg clip
M6401S	Self adhesive hook

Please see page 32 for a list of available cabinet sizes  
Bespoke cabinet size options are available on request.

# STATIC & MOBILE CABINETS

## CATHETER STORAGE

- Holds all styles and sizes of catheter packages: hooks, shelves or tote boxes and bins.
- Catheters can be easily organised by dedicating a catheter hook or series of hooks.
- Easily secured onto bars and can be adjusted to accommodate peel pouches.
- 127mm polyurethane swivel castors, two with brakes, allow for easy manoeuvrability.



Q009 cart including bins, rails and hooks.



Q007 cart including bins, rails, shelves and hooks.

### CATHETER STORAGE TROLLEYS

Code	W (mm) D (mm)	Description	Hooks	Max No Per bar
Q009	1219 x 610	4 Bars 1219mm	16	4
Q007	1524 x 610	Combination 3 side shelves - 610mm 4 Bars 914mm	24	6



BAR HOOK ASSEMBLY



CATHETER SIDE BAR



CONTAINERS

### ACCESSORIES

Description	Code
Catheter hooks and label holder plus label	Q1010
Catheter side bar	Q1012
Catheter bar 914mm	Q1013
Catheter bar 1524mm	Q1014

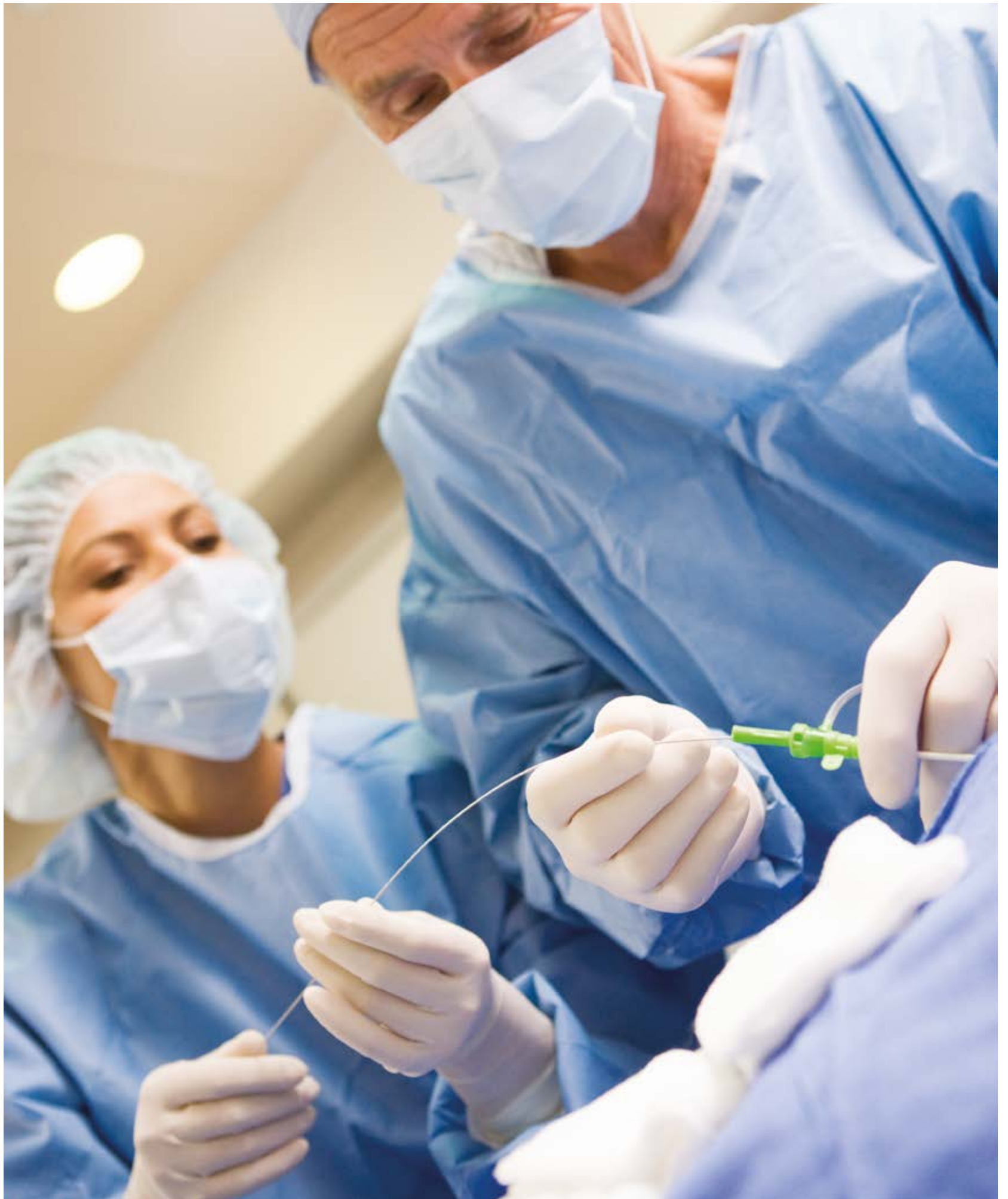



**SXRS72SCATH1**



**SXRD72SCATH2**



**SXRD76MCATH2**

## CATHETER CABINETS

MOBILE AND STATIC HIGH CAPACITY



**CATHETER SHELF**

Self locking removable without tools.



**CATHETER SLIDE**

Built in stop, can hold up to 10 hooks. Pull handle server as label holder slide extension 508mm.



**MOBILE BASE UNIT**

Anti-static castors fitted as standard.

**STATIC CABINETS**

Code	W (mm)	D (mm)	H (mm)	Description
SXRS72SCATH1	635 x	533 x	1829	Single width static catheter module with 1 x 270° locking door, 3 catheter slides, 30 labels and 15 hooks.
SXRD72SCATH1	635 x	1041 x	1829	Double width static cabinet with 2 x 270° locking doors, 2 catheter modules each with 3 catheter sides, 30 labels and 15 hooks.
SXRD72SCATH2	635 x	1041 x	1829	Double width static cabinet with 1 x 270° locking door, 1 catheter module with 3 catheter sides, 30 labels and 15 hooks plus 1 x 76mm, 2 x 150mm and 2 x 230mm drawers, 3 shelves, 270° non-locking door and push handle.

**MOBILE CABINETS**

Code	W (mm)	D (mm)	H (mm)	Description
SXRS76MCATH1	635 x	584 x	1930	Single width mobile catheter module with 1 x 270° locking door, 3 catheter slides, 30 labels and 15 hooks.
SXRD76MCATH1	635 x	1092 x	1930	Double width mobile cabinet with 2 x 270° locking doors, 2 catheter modules each with 3 catheter sides, 30 labels and 15 hooks.
SXRD76MCATH2	635 x	1092 x	1930	Double width mobile cabinet with 1 x 270° locking door, 1 catheter module with 3 catheter sides, 30 labels and 15 hooks plus 1 x 76mm, 2 x 150mm and 2 x 230mm drawers, 3 shelves, 270° non-locking door and push handle.

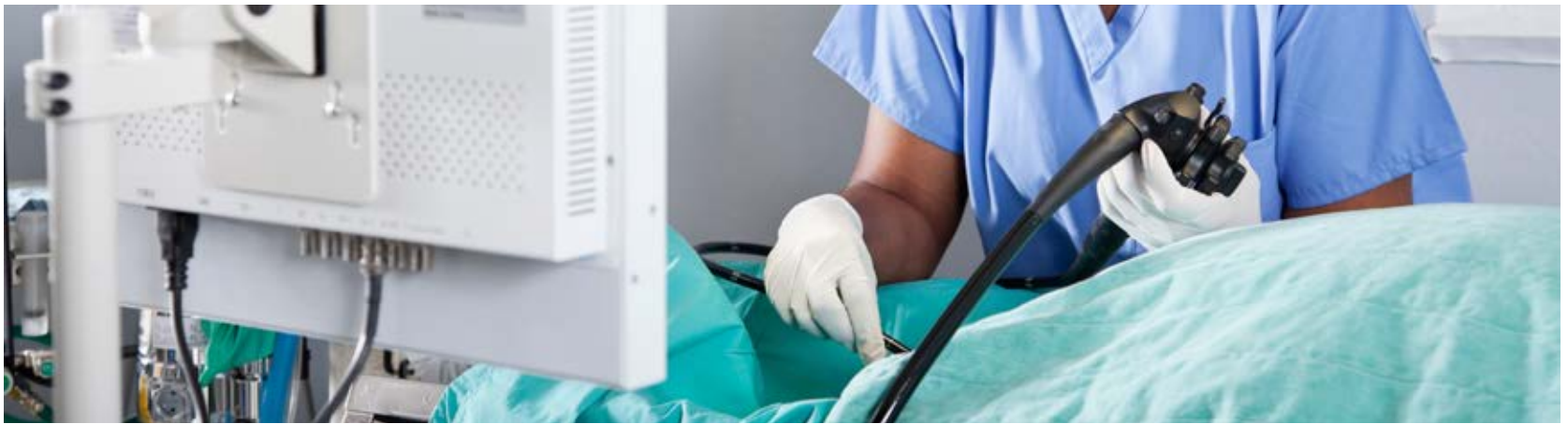

# ENDOSCOPE CABINETS

## POLYMER - HIGH DENSITY STORAGE SOLUTION

- Safe locking tangle-free storage units.
- Highly organised quick access and retrieval of scopes.
- Antimicrobial - Helps keep surfaces clean between cleaning.
- Anti-corrosion cabinet that will not rust, dent or chip.



Clear door right hinged



Solid door left hinged

### RACK ROTATION

Providing access to any scope within the cabinet.

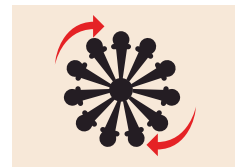

### CORD MANAGER

Stops tangling and provides strain relief for light box connectors. Orange coated design.



### SCOPE BRACKETS

Cord managers and bottom hoops are adjustable in 25mm increments. (Optional label holders available).



### 2 PIECE DRIP TRAY

Contains remaining fluids, easy to clean and dry.



### POLYMER SCOPE CABINETS

Code	W (mm)	D (mm)	H (mm)	Description
SXRS88WSC1LS	549	x 622	x 2261	Single-wide scope cabinet/left-hinged SOLID locking door with 11GI Scope Brackets.
SXRS88WSC1RS	549	x 622	x 2261	Single-wide scope cabinet/right-hinged SOLID locking door with 11GI Scope Brackets.
SXRS88WSC1LC	549	x 622	x 2261	Single-wide scope cabinet/left-hinged CLEAR locking door with 11GI Scope Brackets.
SXRS88WSC1RC	549	x 622	x 2261	Single-wide scope cabinet/right-hinged CLEAR locking door with 11GI Scope Brackets.
SXRD88WSC1	1098	x 622	x 2261	Double-wide scope cabinet/left & right-hinged SOLID locking door with 22GI Scope Brackets.

### DOOR OPTIONS

Solid or clear ventilated locking doors left or right hinged opening.

### VENTS

Strategically located at top and bottom of door to allow maximum air flow.

### ACCESSORIES

#### SCOPE BRACKET LABEL HOLDERS

Label holder kit provides a lightweight, easy read, waterproof identification system. **Code:** SXRSCPLBL



SOLID OR CLEAR DOOR



DOOR VENTS



LABEL HOLDERS



- High volume storage and product segregation cabinets.
- Full face 100% product visibility.
- Perfect for optimum suture storage.
- Selection of colour options and finishes.

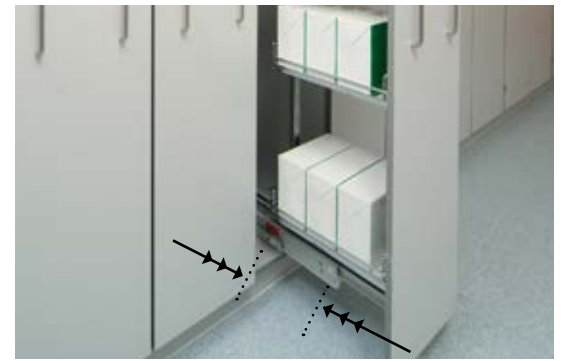

#### EASY TO MANOEUVRE

Larder style top and bottom easy glide runners.



#### CABINET SHELVES

Polished chrome height adjustable shelves fitted to maximise storage.

**FREE SITE SURVEY - PLEASE ARRANGE A SITE VISIT TO TAILOR YOUR EXACT REQUIREMENTS.**

## PULL OUT CABINETS – LARDER UNITS

### SPACE SAVING SOLUTIONS

#### PULL OUT CABINETS

Code	W (mm)	D (mm)	H (mm)	Description
M46211000	400	x 633	x 2100	Cabinet with 5 shelves
M46211101	400	x 633	x 2100	Additional shelf

Shelves are Linear Chrome Wire and a maximum of 7 can be fitted in a 2100 cabinet

#### SUTURE CARRIERS

Code	Description
SUTURE8	8 large boxes / 16 small
SUTURE9	Extends SUTURE8 to double the capacity



Lightweight easy assembly suture carriers single or double sided.

# PATIENT FURNITURE

## BEDSIDE CABINETS AND OVERBED TABLES

- Extremely strong and durable bedside cabinets.
- Removable drawers and internals for deep cleaning.
- Mobile lockable 65mm castors with sturdy corner buffers.
- Available in various colour options with bespoke sizes available on request.



Bespoke combinations and sizes available on request.



### CONSTRUCTION

Built from robust materials with quality hinges and fittings.



### MOULDED PROTECTIVE TOP

Thermoplastic top prevents liquid spillages and increases overall patient area hygiene.



### SECURITY

Lock with nurses station master key as standard. Electronic code locking and proximity options also available.



### STORAGE RAILS

Rear fitting towel and wardrobe rails are fitted as standard.

### BEDSIDE CABINET UNITS:

Cabinet	Description	W (mm)	D (mm)	H (mm)
MB4402	2 drawer cabinet with lock	450	x 470	x 850
MB4403	3 drawer cabinet with lock	450	x 470	x 850





# OVERBED & CHAIR TABLES

## WARD UNIT FURNITURE

- Lightweight, durable and easy to clean.
- Designed for patient use in bed and seated.
- Safe working load of 25Kg - Evenly distributed.
- 2 top style options.
- Beech, Blue or Grey top options.
- 50mm twin wheel castors.



### FULLY ADJUSTABLE

Height adjustment range of 710-1080mm.  
Tilting top surface is 900mm x 420mm and fixes in a variety of positions.



### OVER BED & CHAIR TABLE

Code	W (mm)	D (mm)	H (mm)	Description
MS3211	900	x 420	x 710 - 1080	Solid top surface
MS3212	900	x 420	x 710 - 1080	Split top surface

# PATIENT CHART HOLDER

## SPECIFICALLY DESIGNED FOR PATIENT CHARTING SYSTEMS



- Stores and protects patient files.

### ORGANISATION

Built to store and transport a range of file sizes.

### EASY TO MANOEUVRE

4 125mm castors with non marking, buffered wheels with locking brakes.



### FULLY WELDED FRAME

Extremely strong frame design in a selection of colours.

### EASY TO CLEAN

Removable file holders.

### MOBILE CHART HOLDER:

Cabinet	Description	W (mm)	D (mm)	H (mm)
MC2500-60	60 capacity holders	1250	x 385	x 1750
MC2500-30	30 capacity holders	850	x 385	x 1400
MC2500-20	20 capacity holders	850	x 385	x 1050
MC2500-15	15 capacity holders	450	x 385	x 1400





## HTM 63 FURNITURE SYSTEM

STORAGE UNITS WITH SHELVES

### VERSATILE IN USE

Fully compatible with HTM 63 HBN standards for healthcare use, pre-drilled holes allow for storage shelves to be adjusted to your individual height requirements. Matching low level units provide additional drawer and cabinet space with a selection of hygienic worktop units.

ALL STORAGE UNITS ARE BESPOKE FITTED...



**High pressure laminate doors:**  
Available in bold colours to offer  
a contemporary design finish.

# HTM 63 BASE CABINETS

## 860mm HIGH SINGLE

- Fitted furniture solutions.
- A range of standard widths.
- Bespoke heights available.
- Available in various colour options.
- A10 locks fitted as standard.
- Integral worktops and support systems.
- Sloping and bulkhead tops available as standard.
- Fixed or adjustable internal shelves.

**PLEASE CONTACT MEDSTOR FOR ADDITIONAL INFORMATION OR TO SCHEDULE AN INFORMAL MEETING.**

- Melamine, Laminate, Glass or Polycarbonate door styles are available.



**CABINET: 860mm**

Code	Width	Depth
B0308	300	500
B0408	400	500
B0508	500	500
B0608	600	500



**LEFT HAND DOOR 860mm**

Code	Width	Depth
B0308LH	300	500
B0408LH	400	500
B0508LH	500	500
B0608LH	600	500



**RIGHT HAND DOOR: 860mm**

Code	Width	Depth
B0308RH	300	500
B0408RH	400	500
B0508RH	500	500
B0608RH	600	500



**SPLIT DOORS: 860mm**

Code	Width	Depth
M0308SD	300	500
B0408SD	400	500
B0508SD	500	500
B0608SD	600	500



**4 DRAWER CABINET: 860mm**

Code	Width	Depth
B03084D	300	500
B04084D	400	500
B05084D	500	500
B06084D	600	500



**SPLIT DOOR & DRAWER 860mm**

Code	Width	Depth
B0308SDD	300	500
B0408SDD	400	500
B0508SDD	500	500
B0608SDD	600	500



**LEFT HAND DOOR & DRAWER 860mm**

Code	Width	Depth
B0308LDD	300	500
B0408LDD	400	500
B0508LDD	500	500
B0608LDD	600	500



**RIGHT HAND DOOR & DRAWER 860mm**

Code	Width	Depth
B0308RDD	300	500
B0408RDD	400	500
B0508RDD	500	500
B0608RDD	600	500

**5 DRAWER CABINET: 860mm**

Code	Width	Depth
B03085D	300	500
B04085D	400	500
B05085D	500	500
B06085D	600	500

# HTM 63 DOUBLE BASE CABINETS

## 860mm HIGH DOUBLE

- Fitted furniture solutions.
- A range of standard widths.
- Bespoke heights available.
- Available in various colour options.
- A10 locks fitted as standard.
- Integral worktops and support systems.
- Sloping and bulkhead tops available as standard.
- Fixed or adjustable internal shelves.

PLEASE CONTACT MEDSTOR FOR ADDITIONAL INFORMATION OR TO SCHEDULE AN INFORMAL MEETING.

- Melamine, Laminate, Glass or Polycarbonate door styles are available.



**CABINET: 860mm**

Code	Width	Depth
B0808	800	500
B1008	1000	500
B1208	1200	500



**OPEN WITH LEFT HAND DOOR: 860mm**

Code	Width	Depth
B0808OLH	800	500
B1008OLH	1000	500
B1208OLH	1200	500



**OPEN WITH RIGHT HAND DOOR: 860mm**

Code	Width	Depth
B0808ORH	800	500
B1008ORH	1000	500
B1208ORH	1200	500



**SPLIT DOORS: 860mm**

Code	Width	Depth
B0808SD	800	500
B1008SD	1000	500
B1208SD	1200	500



**8 DRAWER CABINET: 860mm**

Code	Width	Depth
B08088D	800	500
B10088D	1000	500
B12088D	1200	500



**SPLIT DOOR & DRAWER 860mm**

Code	Width	Depth
B0808SDD	800	500
B1008SDD	1000	500
B1208SDD	1200	500



**LEFT HAND DOOR & DRAWER 860mm**

Code	Width	Depth
B0808LDD	800	500
B1008LDD	1000	500
B1208LDD	1200	500



**RIGHT HAND DOOR & DRAWER 860mm**

Code	Width	Depth
B0808RDD	800	500
B1008RDD	1000	500
B1208RDD	1200	500

**10 DRAWER CABINET: 860mm**

Code	Width	Depth
B080810D	800	500
B100810D	1000	500
B120810D	1200	500

**Base cabinet interiors:**

HTM 63 units have shelves fitted as standard -  
Please specify shelf numbers at point of order.

Double units can be fitted with sink worktops  
extending storage space covering service pipework.



**Door options:**  
Choice of door finishes  
and specifications.

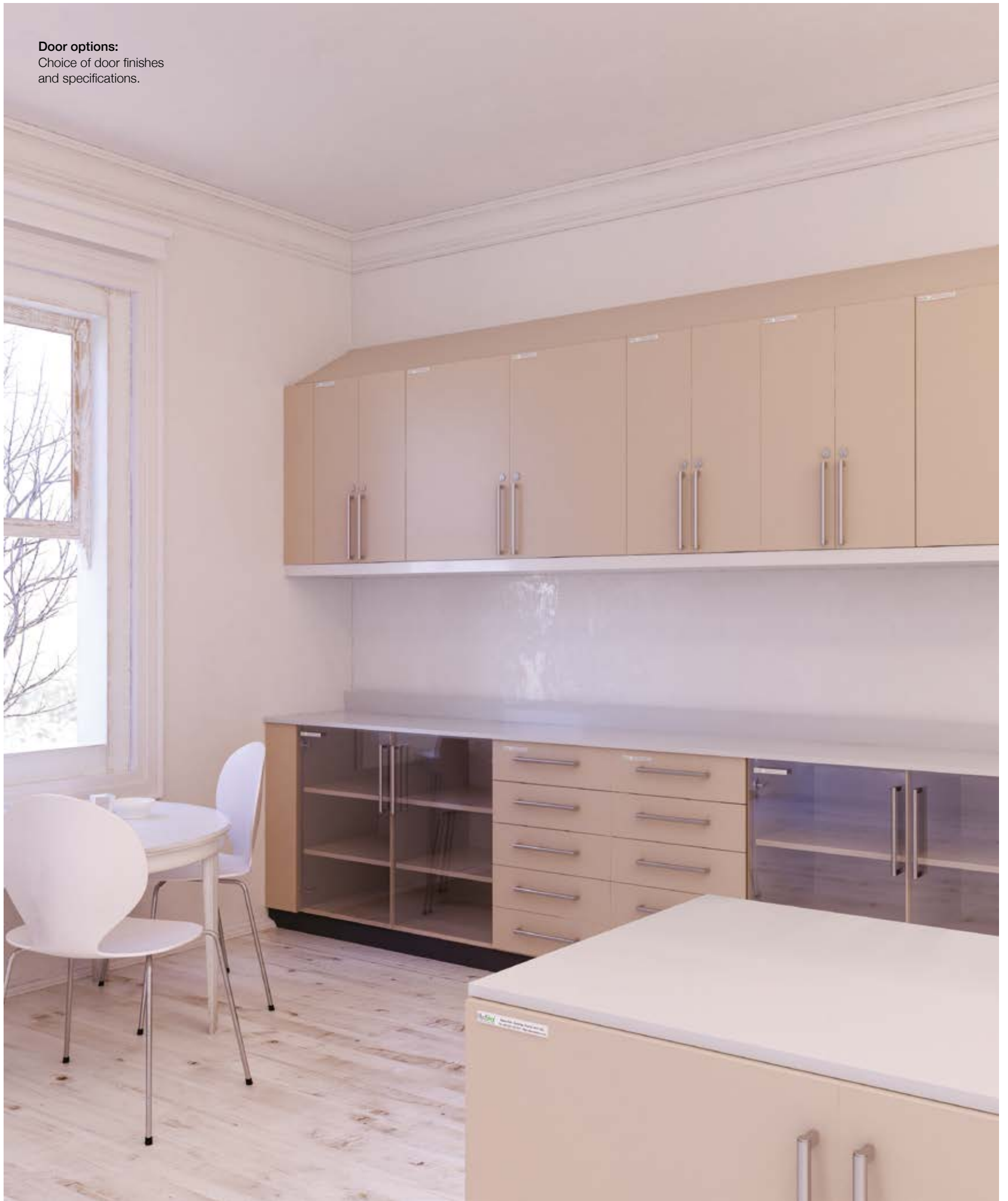



# HTM 63 WALL CABINETS

900, 750, 600 & 550mm HIGH

- Fitted furniture solutions.
- A range of standard widths.
- Bespoke heights available.
- Available in various colour options.
- A10 locks fitted as standard.
- Integral worktops and support systems.
- Sloping and bulkhead tops available as standard.
- Fixed or adjustable internal shelves.

**PLEASE CONTACT MEDSTOR FOR ADDITIONAL INFORMATION OR TO SCHEDULE AN INFORMAL MEETING.**

- Melamine, Laminate, Glass or Polycarbonate door styles are available.



## CABINET: 900mm

Code	Width	Depth
B0309	300	300
B0409	400	300
B0509	500	300
B0609	600	300

## LEFT HAND DOOR: 900mm

Code	Width	Depth
B0309LH	300	300
B0409LH	400	300
B0509LH	500	300
B0609LH	600	300

## RIGHT HAND DOOR: 900mm

Code	Width	Depth
B0309RH	300	300
B0409RH	400	300
B0509RH	500	300
B0609RH	600	300

## SPLIT DOORS: 900mm

Code	Width	Depth
B0309SD	300	300
B0409SD	400	300
B0509SD	500	300
B0609SD	600	300

## CABINET: 750mm

Code	Width	Depth
B0307	300	300
B0407	400	300
B0507	500	300
B0607	600	300

## LEFT HAND DOOR: 750mm

Code	Width	Depth
B0307LH	300	300
B0407LH	400	300
B0507LH	500	300
B0607LH	600	300

## RIGHT HAND DOOR: 750mm

Code	Width	Depth
B0307RH	300	300
B0407RH	400	300
B0507RH	500	300
B0607RH	600	300

## SPLIT DOORS: 750mm

Code	Width	Depth
B0307SD	300	300
B0407SD	400	300
B0507SD	500	300
B0607SD	600	300

## CABINET: 600mm

Code	Width	Depth
B0306	300	300
B0406	400	300
B0506	500	300
B0606	600	300

## LEFT HAND DOOR: 600mm

Code	Width	Depth
B0306LH	300	300
B0406LH	400	300
B0506LH	500	300
B0606LH	600	300

## RIGHT HAND DOOR: 600mm

Code	Width	Depth
B0306RH	300	300
B0406RH	400	300
B0506RH	500	300
B0606RH	600	300

## SPLIT DOORS: 600mm

Code	Width	Depth
B0306SD	300	300
B0406SD	400	300
B0506SD	500	300
B0606SD	600	300

## CABINET: 550mm

Code	Width	Depth
B0305	300	300
B0405	400	300
B0505	500	300
B0605	600	300

## LEFT HAND DOOR: 550mm

Code	Width	Depth
B0305LH	300	300
B0405LH	400	300
B0505LH	500	300
B0605LH	600	300

## RIGHT HAND DOOR: 550mm

Code	Width	Depth
B0305RH	300	300
B0405RH	400	300
B0505RH	500	300
B0605RH	600	300

## SPLIT DOORS: 550mm

Code	Width	Depth
B0305SD	300	300
B0405SD	400	300
B0505SD	500	300
B0605SD	600	300

# HTM 63 DOUBLE WALL CABINETS

900, 750, 600 & 550mm HIGH

- Fitted furniture solutions.
- A range of standard widths.
- Bespoke heights available.
- Available in various colour options.
- A10 locks fitted as standard.
- Integral worktops and support systems.
- Sloping and bulkhead tops available as standard.
- Fixed or adjustable internal shelves.

**PLEASE CONTACT MEDSTOR FOR ADDITIONAL INFORMATION OR TO SCHEDULE AN INFORMAL MEETING.**

- Melamine, Laminate, Glass or Polycarbonate door styles are available.



## CABINET: 900mm

Code	Width	Depth
B0809	800	300
B1009	1000	300
B1209	1200	300



## LEFT HAND DOOR 900mm

Code	Width	Depth
B0809LH	800	300
B1009LH	1000	300
B1209LH	1200	300



## RIGHT HAND DOOR: 900mm

Code	Width	Depth
B0809RH	800	300
B1009RH	1000	300
B1209RH	1200	300



## SPLIT DOORS: 900mm

Code	Width	Depth
B0809SD	800	300
B1009SD	1000	300
B1209SD	1200	300

## CABINET: 750mm

Code	Width	Depth
B0807	800	300
B1007	1000	300
B1207	1200	300

## LEFT HAND DOOR 750mm

Code	Width	Depth
B0807LH	800	300
B1007LH	1000	300
B1207LH	1200	300

## RIGHT HAND DOOR: 750mm

Code	Width	Depth
B0807RH	800	300
B1007RH	1000	300
B1207RH	1200	300

## SPLIT DOORS: 750mm

Code	Width	Depth
B0807SD	800	300
B1007SD	1000	300
B1207SD	1200	300

## CABINET: 600mm

Code	Width	Depth
B0806	800	300
B1006	1000	300
B1206	1200	300

## LEFT HAND DOOR 600mm

Code	Width	Depth
B0806LH	800	300
B1006LH	1000	300
B1206LH	1200	300

## RIGHT HAND DOOR: 600mm

Code	Width	Depth
B0806RH	800	300
B1006RH	1000	300
B1206RH	1200	300

## SPLIT DOORS: 600mm

Code	Width	Depth
B0806SD	800	300
B1006SD	1000	300
B1206SD	1200	300

## CABINET: 550mm

Code	Width	Depth
B0805	800	300
B1005	1000	300
B1205	1200	300

## LEFT HAND DOOR 550mm

Code	Width	Depth
B0805LH	800	300
B1005LH	1000	300
B1205LH	1200	300

## RIGHT HAND DOOR: 550mm

Code	Width	Depth
B0805RH	800	300
B1005RH	1000	300
B1205RH	1200	300

## SPLIT DOORS: 550mm

Code	Width	Depth
B0805SD	800	300
B1005SD	1000	300
B1205SD	1200	300





**Door options:**  
Choice of door finishes and specifications.

# HTM 63 WALL CORNER CABINETS

900, 750, 600 & 550mm HIGH

- Fitted furniture solutions.
- A range of standard widths.
- Bespoke heights available.
- Available in various colour options.
- A10 locks fitted as standard.
- Integral worktops and support systems.
- Sloping and bulkhead tops available as standard.
- Fixed or adjustable internal shelves.

**PLEASE CONTACT MEDSTOR FOR ADDITIONAL INFORMATION OR TO SCHEDULE AN INFORMAL MEETING.**

- Melamine, Laminate, Glass or Polycarbonate door styles are available.



**CABINET: 900mm**

Code	Width	Depth
B6609	600	600



**LEFT HAND DOOR: 900mm**

Code	Width	Depth
B6609LH	600	600



**RIGHT HAND DOOR: 900mm**

Code	Width	Depth
B6609RH	600	600

**CABINET: 750mm**

Code	Width	Depth
B6607	600	600

**LEFT HAND DOOR: 750mm**

Code	Width	Depth
B6607LH	600	600

**RIGHT HAND DOOR: 750mm**

Code	Width	Depth
B6607RH	600	600

**CABINET: 600mm**

Code	Width	Depth
B6606	600	600

**LEFT HAND DOOR: 600mm**

Code	Width	Depth
B6606LH	600	600

**RIGHT HAND DOOR: 600mm**

Code	Width	Depth
B6606RH	600	600

**CABINET: 550mm**

Code	Width	Depth
B6605	600	600

**LEFT HAND DOOR: 550mm**

Code	Width	Depth
B6605LH	600	600

**RIGHT HAND DOOR: 550mm**

Code	Width	Depth
B6605RH	600	600

# HTM 63 BASE CORNER CABINETS

860mm HIGH



**CABINET: 860mm**

Code	Width	Depth
B8808	800	800



**LEFT HAND DOOR 860mm**

Code	Width	Depth
B8808LH	800	800



**RIGHT HAND DOOR: 860mm**

Code	Width	Depth
B8808RH	800	800

# MODULAR NURSES STATION

RECEPTION AREA UNITS



DDA Compliant modular units, installed ready for immediate use.



- Easy clean hygienic laminated MDF panels and worktops certified to FSC standards.
- Robust and stylish units provide functional work surfaces.
- Reconfigurable units give infinite footprint possibilities.
- Suitable for the healthcare sector and public areas.
- Designed and manufactured in the U.K.

**CABLE MANAGEMENT**

Includes 2 port outlets.

**2 HEIGHT OPTIONS**

Normal desk height and riser unit for privacy.

**COUNTER TOPS**

Fixed or floating in a choice of material finishes.



**FIXED OR FLOATING COUNTER TOPS**

Toughened, clear and frosted glass or coloured acrylic finish surfaces.



**MEDSTOR TRAYS AND DIVIDERS**

Manufactured by Medstor in the UK our trays and dividers are focused on content protection. Clear polycarbonate and ABS available.



**INTEGRAL CHANNEL**

For power and data management

**KICK PLATE**

laminated waterproof construction board.

**CONSTRUCTION**

Laminated MDF 18mm panels in a selection of colours.



**CORNER STORAGE UNITS**

Can be adapted to house the Medstor liner and tray system.



**PERSONALISATION**

Panels can be personalised with organisation logos, direction information and LED lighting.

**UNIT FOOTPRINTS**



**NURSE STATION 850mm DEEP UNITS**

Desk	With Riser	Description	W (mm)	D (mm)	H (mm)
D1285	DR1285	Rectangular section	1290	850	750 / 1190
D1585	DR1585	Rectangular section	1590	850	750 / 1190
D2385	DR2385	Rectangular section	2390	850	750 / 1190

**CORNER UNITS**

Desk	With Riser	Description	W (mm)	D (mm)	H (mm)
D1685	DC1685	60° internal corner	1600	850	750 / 1190
D2685	DC2685	90° internal corner	2260	850	750 / 1190
D2285	DC2285	60° external corner	2200	850	750 / 1190

**CORNER STORAGE UNITS**

Cupboard	With door	Description	W (mm)	D (mm)	H (mm)
D3085R	D3085RD	Right hand storage	300	850	1200
D3085L	D3085LD	Left hand storage	300	850	1200

**CORNER STORAGE UNITS WITH LINERS**

Cupboard	With door	Description	W (mm)	D (mm)	H (mm)
D3585R	D3585RD	Right hand storage	355	850	1200
D3585L	D3585LD	Left hand storage	355	850	1200

**SAMPLE CONFIGURATIONS**

As each project has individual requirements and specifications: Please contact Medstor for a free site survey - See example configurations below:



**EXAMPLE 1**

- S-shape using 4 x corner units



**EXAMPLE 2**

- 1 x DDA desk unit
- 2 x Storage units
- 2 x Desk units with riser for privacy

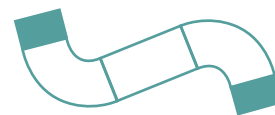

**EXAMPLE 3**

- 1 x Riser unit
- 2 x Storage units with liners
- 2 x Corner units

**BESPOKE LAYOUT ?**

We help develop your big or small project.

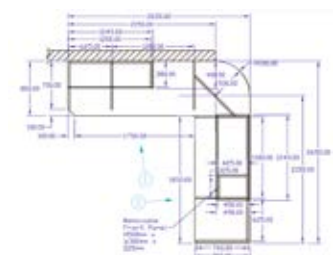

# STOCK CONTROL AREAS

EFFICIENT STORAGE - MAXIMISING YOUR SPACE

## SCALABLE IN SIZE

Flexible systems suitable for small local storage areas to large open plan central stores.

Capable of handling all different sizes of materials and stock level demands with the flexibility to adapt over time.



### FREE DESIGN AND CONSULTATION SERVICE AVAILABLE

To help develop your project big or small, our talented in-house space planners produce 2D and 3D visuals of the required project.





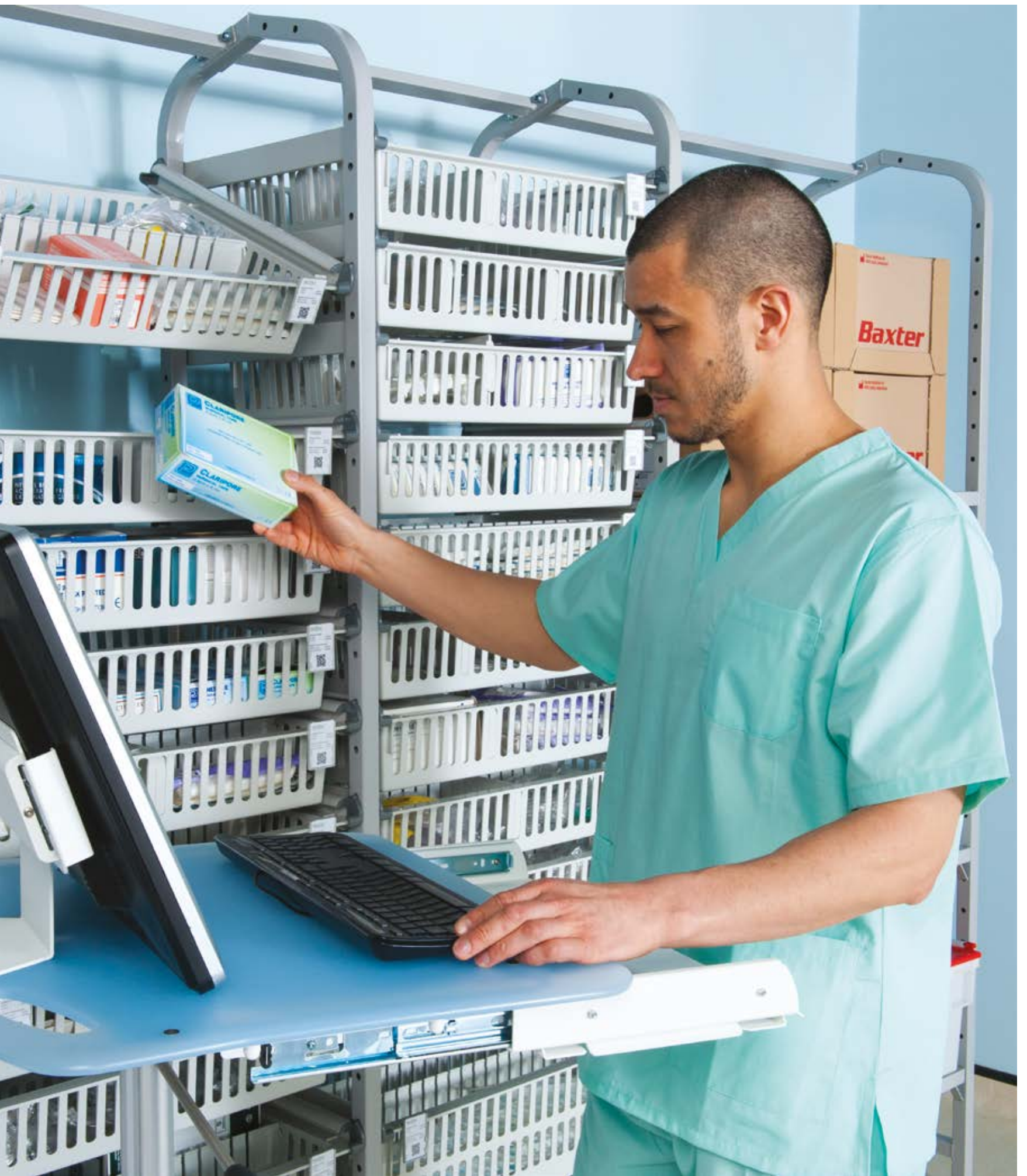

# LONG SPAN SHELVING

## FOOTPRINTS FOR ALL ROOM SIZES

- **Static or mobile storage system.**
- **Infection control - simple to clean smooth surfaces.**
- **467mm or 667mm deep units.**

### STARTER KIT END FRAME

467mm deep or 667mm deep mobile or static option.

### LONG SPAN BAY KIT

Includes end post with built in horizontal connectors.

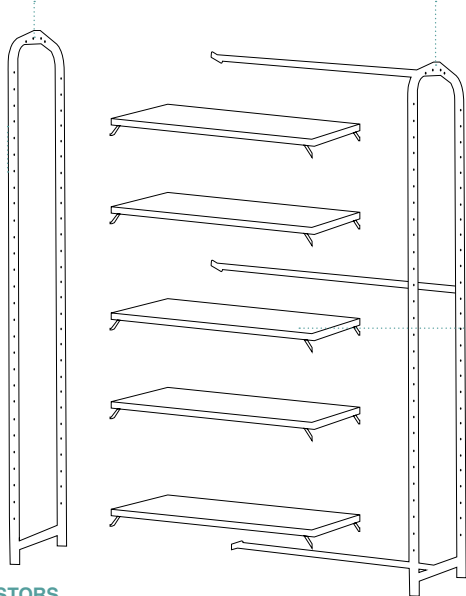

### LONG SPAN SHELF KIT

Contains 1 shelf with 4 adjustable support brackets. Perforated or solid front.

### CASTORS

Can be fitted to units to make a fully mobile unit.

### COST EFFECTIVE STANDARD HTM 71 SOLUTION

Bulk storage system produced in the UK by Medstor, giving you full product continuity.



### TOOL FREE INSTALLATION

Constructed from 30mm box section tubes with adjustable feet for uneven floor surfaces.



### 250Kg WORKLOAD PER SHELF

Easily adjusted shelves utilise fitted corner brackets located in the pre drilled end posts providing bolt free adjustment.



### PRODUCT CONTROL SHELF OPTIONS

Perforated front shelving ready to incorporate our materials management labelling system, alternatively a solid front kit as standard.



### WORKING TOGETHER

Long span shelving works seamlessly with High density shelving system.

### HOW TO SPECIFY

- Each run/section requires a 467mm or 667mm deep starter kit / end frame.
- Add shelf numbers with Long span shelf kit bay.
- Finish with a Long span end bay to create the correct amount of storage.

### FREE PLANNING SERVICE

To help develop your big or small project.

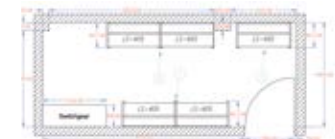

### LONG SPAN 467mm DEEP FRAME

Static	Mobile	Description	W (mm)	D (mm)	H (mm)
EF401	MEF401	Starter kit end frame	30	467	2130
LS401	MLS401	Long span bay kit	970	467	2130

### 467mm DEEP SHELF KIT

Solid front	Perforated front	Description	W (mm)	D (mm)	H (mm)
M692-1	M692-9	Shelf with brackets	947	465	30/60

### LONG SPAN 667mm DEEP FRAME

Static	Mobile	Description	W (mm)	D (mm)	H (mm)
EF601	MEF601	Starter kit end frame	30	667	2130
LS601	MLS601	Long span bay kit	970	667	2130

### 667mm DEEP SHELF KIT

Solid front	Perforated front	Description	W (mm)	D (mm)	H (mm)
M690-1	M690-9	Shelf with brackets	947	665	30/60

### PROJECT ENVIRONMENTS



#### HOSPITAL C.S.S.D DEPARTMENT:

Large centrally located hospital store area

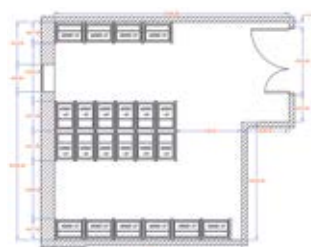

#### EQUIPMENT STORE:

26 bay layout with back to back aisle

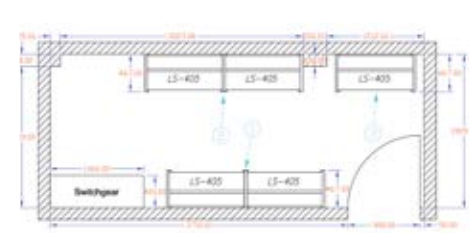

#### PHARMACY STORE:

5 bay room installation



Multi-purpose storage that adapts to your storage area requirements.



**WORKING WITH STOCK LEVELS:**  
Clear card labelling shelf system incorporated into shelf kit design.



# HTM 71 HIGH DENSITY SHELVING

SPECIFICALLY DESIGNED TO PROVIDE CLEAN SURFACES

- High density is both a free standing or mobile storage system.
- Infection control - simple to clean smooth surfaces.
- 467mm or 667mm deep units.

Space saving simple alternative to large storage cabinet.



**STARTER KIT END FRAME**

467mm deep or 667mm deep  
Mobile or static option

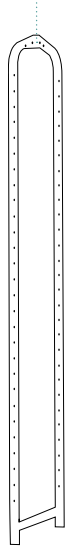

**RUNNER KITS**

- Telescopic
- Horizontal
- Angled



**TRAY SELECTION**

Choice of sizes, materials, dividers and labels

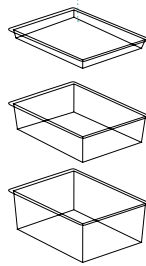

**HIGH DENSITY BAY KIT**

Includes end post with built-in horizontal connectors

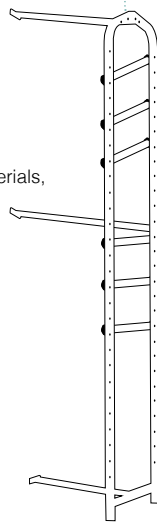

**WORKING TOGETHER**

High density shelving works seamlessly with Long span shelving.

**HOW TO SPECIFY**

- Each run/section requires a 467mm or 667mm deep starter kit / end frame.
- Add Tray runner kit (each kit contains 2 runners to support 1 tray).
- Finish with a high density bay kit to create the correct amount of storage.

**HIGH DENSITY 467mm DEEP FRAME**

Static	Mobile	Description	W (mm)	D (mm)	H (mm)
EF401	MEF401	Starter kit end frame	30	467	2130
HD401	MHD401	High density bay kit	643	467	2130

**TRAY RUNNER KTS FOR 467mm RACKING**

Angled	Horizontal	Telescopic
M674-1	M673-1	T673-1

**TRAY CODES**

- Extensively used in the healthcare sector see pages 18-23 for full specification.
- Tough clear polycarbonate or grey ABS.
- 50mm, 100mm and 200mm high.



W (mm)	D (mm)	H (mm)
600	400	50
600	400	100
600	400	200

**POLYCARBONATE TRAYS**

Open sides with solid base	Open sides and open base	Solid sides and solid base
-	-	M1605
M1601	M1651	M1611
M1602	-	M1612

**ABS TRAYS**

Open sides with solid base	Open sides and open base	Solid sides and solid base
-	-	M0605
M0601	M0651	M0611
M0602	-	M0612

**DIVIDER CODES**



**POLYCARBONATE DIVIDERS**

USED WITH	Short 400mm	Long 600mm
50mm high tray	M1645	M1665
100mm high tray	M1641	M1661
200mm high tray	M1642	M1662

**ABS DIVIDERS**

Used with	Short 400mm	Long 600mm
50mm high tray	M0645	M0665
100mm high tray	M0641	M0661
200mm high tray	M0642	M0662

**T CLIP - Code F112**

For snappable dividers 30 x 30 x 30



**TELESCOPIC RUNNER**

Stainless steel ball bearing runners for smooth full withdrawal of Medstor trays. Soft closure with anti-tilt technology protects container contents and ensures user safety.



**24° ANGLED RUNNER**

Holds the tray securely in the closed position ready for withdrawal.



**HORIZONTAL RUNNERS**

Positive arrester system to ensure non accidental removal of baskets.



**STOCK CONTROL**

Post fitting stock identification card holder. Code F302

**FREE PLANNING SERVICE**

To help develop your big or small project.

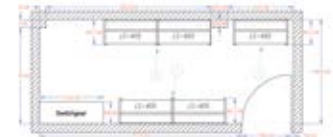

**HIGH DENSITY 667mm DEEP FRAME**

Static	Mobile	Description	W (mm)	D (mm)	H (mm)
EF601	MEF601	Starter kit end frame	30	667	2130
HD601	MHD601	High density bay kit	443	667	2130

**TRAY RUNNER KTS FOR 667mm RACKING**

Angled	Horizontal	Telescopic
M676-1	M675-1	T675-9

# TOPTRACK HIGH DENSITY

## ACTIVE AISLE MOBILE STORAGE SYSTEM

- Overhead Track System.
- Maximise storage within limited floor space areas.
- Ideal for frequently cleaned floor areas.
- 408kg evenly distributed capacity per mobile unit.



### WHY USE ACTIVE AISLES?

Toptrack enables more storage to fit within limited floor space.



### EXAMPLE TRADITIONAL STORAGE

Using up to 6m of space.



### SPACE SAVING

Up to 50% extra with top track

Please ensure you allow for a minimum 762mm active aisle within track length for unit access to mobile units.



### OVERHEAD ALUMINIUM TRACK

Fits between stationary end units creating stability and easy movement of mobile units



### EASY TO MANOEUVRE

Rigid channels and large wheel design helps mobile units to be moved easily



### TRACK SIZE OPTIONS

Designed to maximise all available storage space.

**Please request our free planning service.**



### SHELF OPTIONS

Metromax Q Open Grid Polymer Shelving System supplied as standard .

Metromax I Open Grid/Solid Polymer Shelving and Chrome Wire System available on request.

### TOPTRACK High Density Storage is configured by specifying 4 components

- 457mm or 610mm deep static end kits
- 457mm or 610mm deep mobile unit kits
- Desired shelf size
- Desired Track Length (Please ensure you allow for a minimum 762mm active aisle within track length for access to mobile units)

#### STATIONARY END UNIT KITS

457mm width	610mm width
Q70180000	Q70240000

Includes:  
Stationary post and hardware to connect track sets together  
One static section kit per full layout is required. Overall unit height 2195mm.

#### MOBILE UNIT KITS

457mm width	610mm width
Q70180001	Q70240001

Includes:  
Mobile posts, castors, castor channels, bumpers and roller assemblies.

#### 457mm WIDTH BAY UNIT - SHELF LENGTH

910mm	1220mm	1525mm	1829mm
Q18360000	Q18480000	Q18600000	Q18720000

Metromax Q polymer grid mat shelves supplied as standard  
Please specify number of shelves at point of order – min 4 recommended per stationary and mobile kit for stability.

#### 610mm WIDTH BAY UNIT - SHELF LENGTH

910mm	1220mm	1525mm	1829mm
Q24360000	Q24480000	Q24600000	Q24720000

Metromax Q polymer grid mat shelves supplied as standard  
Please specify number of shelves at point of order – min 4 recommended per stationary and mobile kit for stability.

#### TRACK SET - RUN LENGTHS

Track Length	Code
1830mm track	Q77000006
2135mm track	Q77000007
2440mm track	Q77000008
2745mm track	Q77000009
3050mm track	Q77000010
3355mm track	Q77000011
3660mm track	Q77000012
3965mm track	Q77000013
4270mm track	Q77000014
4575mm track	Q77000015
4880mm track	Q77000016
5185mm track	Q77000017
5490mm track	Q77000018
5795mm track	Q77000019
6100mm track	Q77000020
6405mm track	Q77000021



### PROTECTIVE FLOOR PADS

### ACCESSORIES

Floor pad protectors compensate for soft flooring materials by protecting the floor from wear and tear.  
Please specify floor pad length in conjunction with track length at point or order.

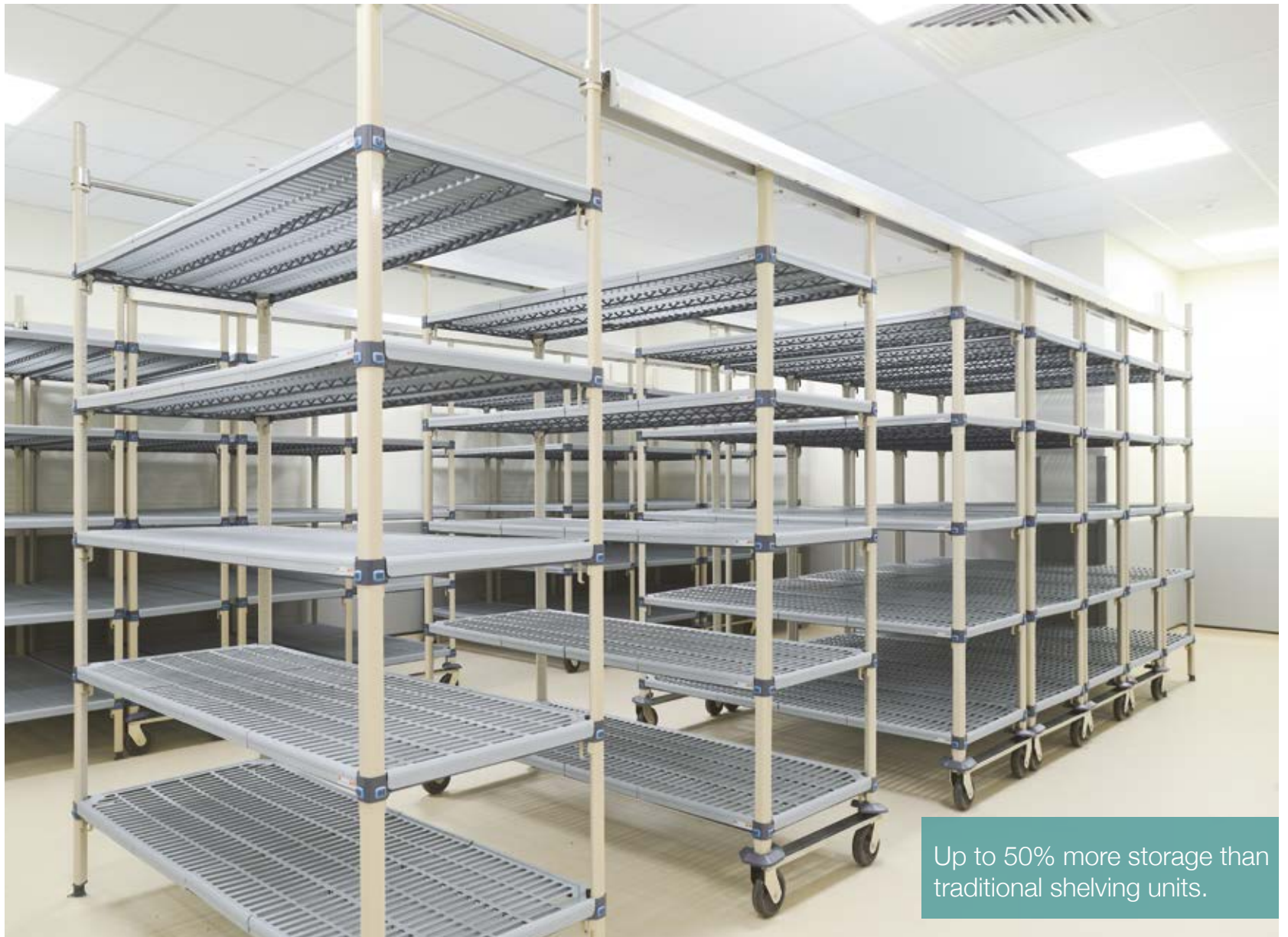

Up to 50% more storage than traditional shelving units.



**MEDSTOR CASE STUDY IMAGES**  
Taken from a finished storage project installation for the NHS.



# qwikTRAK HIGH DENSITY

## ACTIVE AISLE MOBILE STORAGE SYSTEM

- Floor Track System.
- Maximise storage within limited floor space areas.
- Ideal for heavy duty applications.
- 907kg evenly distributed capacity per mobile unit.



### WHY USE ACTIVE AISLES?

qwikTRAK enables more storage to fit within limited floor space.



### EXAMPLE TRADITIONAL STORAGE

Using up to 6m of space.



### SPACE SAVING

Up to 50% extra with top track

Please ensure you allow for a minimum 762mm active aisle within track length for unit access to mobile units.



### FLOOR MOUNTED TRACK SYSTEM

Floor tracks provide a smooth, level surface to guide the mobile units in a straight line.



### EASY TO MANOEUVRE

V Groove castor design helps mobile units roll easily along the track even with heavy loads.



### TRACK SIZE OPTIONS

Designed to maximise all available storage space options.

**Please request our free planning service.**



### SHELF OPTIONS

Metromax Q Open Grid Polymer Shelving System supplied as standard  
Metromax I Open Grid/Solid Polymer Shelving and Chrome Wire System available on request.

qwikTRAK High Density Storage is configured by specifying 4 components

- Stationary end kit
- Mobile unit kit
- Desired shelf size
- Desired Track Length (Please ensure you allow for a minimum 762mm active aisle within track length for access to mobile units)

### STATIONARY END UNIT KITS

Description	Code
Kit suits 457mm deep and 610mm deep shelves	Q70180022

Includes stationary post and hardware to connect unit to track sets.  
One static section kit per full layout is required. Overall unit height 1880mm.

### MOBILE UNIT KIT

Description	Code
Kit suits 457mm deep and 610mm deep shelves	Q70180021

Includes:  
Mobile posts, castors, bumpers and hardware.

### 457mm WIDTH BAY UNIT - SHELF LENGTH

910mm	1220mm	1525mm	1829mm
Q18360000	Q18480000	Q18600000	Q18720000

Metromax Q polymer grid mat shelves supplied as standard  
Please specify number of shelves at point of order – min 4 recommended per stationary and mobile kit for stability.

### 610mm WIDTH BAY UNIT - SHELF LENGTH

910mm	1220mm	1525mm	1829mm
Q24360000	Q24480000	Q24600000	Q24720000

Metromax Q polymer grid mat shelves supplied as standard  
Please specify number of shelves at point of order – min 4 recommended per stationary and mobile kit for stability.

### TRACK SET - RUN LENGTHS

Track Length	Code
1830mm track	Q77002006
2135mm track	Q77002007
2440mm track	Q77002008
2745mm track	Q77002009
3050mm track	Q77002010
3355mm track	Q77002011
3660mm track	Q77002012
3965mm track	Q77002013
4270mm track	Q77002014
4575mm track	Q77002015
4880mm track	Q77002016
5185mm track	Q77002017
5490mm track	Q77002018
5795mm track	Q77002019
6100mm track	Q77002020
6405mm track	Q77002021







# Metromax Q

## STORAGE SOLUTION



The unique corner release allows shelves to be repositioned in seconds. Smooth, easy to clean surfaces and epoxy coated components, with Microban antimicrobial product protection provide superior performance and an excellent return on investment.

- Quick to adjust shelves provide maximum usage of space.
- Quick to assemble – patented corner release system.
- 15 year warranty against corrosion.
- Smooth polymer mats protect stored items and remove easily for cleaning.
- Can be integrated with Metromax I Shelving.



Integration with Metromax I solid mat



Metromax Q High Density Storage is configured by using 2 components  
1585mm H or 1895mm High Posts and your desired shelf size. Use mobile posts with castors for mobile applications

### STATIC POSTS

1585mm high	1880mm high
Q63S	Q74S

### MOBILE POSTS

1585mm high	1880mm high
Q63M	Q74M

### 457mm WIDTH BAY UNIT - GRID SHELF LENGTH

910mm	1220mm	1525mm	1829mm
Q18360000	Q18480000	Q18600000	Q18720000

MAX SHELF CAPACITY Maximum bay capacity 900kg			
365kg	365kg	275kg	275kg

### 610mm WIDTH BAY UNIT - GRID SHELF LENGTH

910mm	1220mm	1525mm	1829mm
Q24360000	Q24480000	Q24600000	Q24720000

MAX SHELF CAPACITY Maximum bay capacity 900kg			
365kg	365kg	275kg	275kg

### ACCESSORIES



#### CASTORS – 2 SWIVEL & 2 BRAKED

Allow shelving units to be moved easily for cleaning and access to floor and walls.

#### Mobile castor set: Q5010SET

Add 150mm to overall height of unit and reduce load capacity to 339kg per unit.



#### DIVIDERS

Create organised compartments and separate shelf contents - 200mm high.

#### 455mm deep shelves: Q1801

#### 610mm deep shelves: Q2401



#### SIDE LEDGES

Snap on to help retain product on shelves. Stackable to contain larger items.

#### Side Ledges: Specify at point of order

#### Back Ledges: Specify at point of order



#### LABEL HOLDERS

100mm Snap on to help identify contents. Other lengths and label holder covers are available.

#### Holder: Q04LH



# Metromax I

## LIFETIME STORAGE SOLUTION



The innovative design all polymer post and shelf system is completely corrosion proof. Smooth, easy to clean surfaces promote a cleaner environment and Microban antimicrobial product protection provide an unrivalled future proof performance.

- Easy to adjust shelves provide maximum usage of space.
- Easy to assemble, patented wedge corner system.
- Lifetime warranty against corrosion.
- Available in grid and solid mat options.
- Smooth polymer grid mats remove easily for cleaning.
- Smooth solid mats are ideal for sterile packs.
- Can be integrated with Metromax Q Shelving.



Metromax I Shelving is configured by using 2 components

1585mm H or 1895mm High Posts and your desired shelf size. Use mobile posts with castors for mobile applications.

### STATIC POSTS

1585mm high	1895mm high
Q63SI	Q74SI

### MOBILE POSTS

1585mm high	1895mm high
Q63MI	M74MI

### 455mm WIDTH BAY UNIT - GRID SHELF LENGTH

910mm	1220mm	1525mm	1829mm
Q1836GI	Q1848GI	Q1860GI	Q1872GI

### 455mm WIDTH BAY UNIT - SOLID SHELF LENGTH

Q1836FI	Q1848FI	Q1860FI	Q1872FI
---------	---------	---------	---------

MAX SHELF CAPACITY			
365kg	365kg	275kg	275kg

### 610mm WIDTH BAY UNIT - GRID SHELF LENGTH

910mm	1220mm	1525mm	1829mm
Q2436GI	Q2448GI	Q2460GI	Q2472GI

### 610mm WIDTH BAY UNIT - SOLID SHELF LENGTH

Q2436FI	Q2448FI	Q2460FI	Q2472FI
---------	---------	---------	---------

MAX SHELF CAPACITY			
365kg	365kg	275kg	275kg

### ACCESSORIES



#### CASTORS – 2 SWIVEL & 2 BRAKED

Allow shelving units to be moved easily for cleaning and access to floor and walls.

**Mobile castor set:** Q5010SET

Add 150mm to overall height of unit and reduce load capacity to 339kg per unit.



#### DIVIDERS

Create organised compartments and separate shelf contents - 200mm high.

**455mm deep shelves:** Q1801

**610mm deep shelves:** Q2401



#### SIDE LEDGES

Snap on to help retain product on shelves. Stackable to contain larger items.

**Side Ledges:** Specify at point of order

**Back Ledges:** Specify at point of order



#### LABEL HOLDERS

100mm Snap on to help identify contents. Other lengths and label holder covers are available.

**Holder:** Q04LH

# SWIFT RACKING

## VERSATILE CLICK AND GO STORAGE SYSTEM

- Ingenious racking system which is easy to assemble.
- Slots together without the use of any nuts and bolts.
- Hygienic, versatile and strong - Injection moulded polypropylene with steel core.
- Rustproof.
- Dishwasher safe polypropylene.
- Free-standing or mobile version.

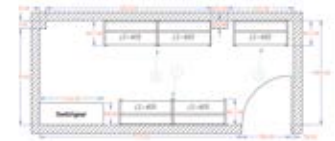

### FREE PLANNING SERVICE

To help develop your project big or small, our talented in-house space planners produce 2D and 3D visuals of the required project.



Suitable for low temperature use to - 30°C.

- 150Kgs LOAD BEARING Per shelf capacity
- 600Kgs MAXIMUM SECTION Per section

Length (mm)	1500mm		1800mm	
	400mm Deep	600mm deep	400mm deep	600mm deep
675	A0645	A0665	A0648	A0668
975	A0945	A0965	A0948	A0968
1375	A1345	A1365	A1348	A1368
1775	A1745	A1765	A1748	A1768

### SPECIFY

Specify the type of shelf: P for plate. F for Grill.  
 Specify if starter or extension bay:- S for starter bay, E straight extension R for right angle extension.  
 Specify if units are free standing or mobile:- F for free standing, M for mobile.



ADDITIONAL SHELVES



CASTORS



**Application areas:**  
Kitchen stores, food preparation areas and wet rooms.

# STERILE SERVICES

O.R. - CSSD - STORAGE - SPECIALIST CARTS

## TWO TOUCH SYSTEM

From sterile services to operating theatres, procedure packs are only touched twice to help maintain sterility and greatly reducing infection risk.

ALL STERILISATION EQUIPMENT IS TESTED FOR AUTOCLAVE PRESSURE CHAMBER USE.



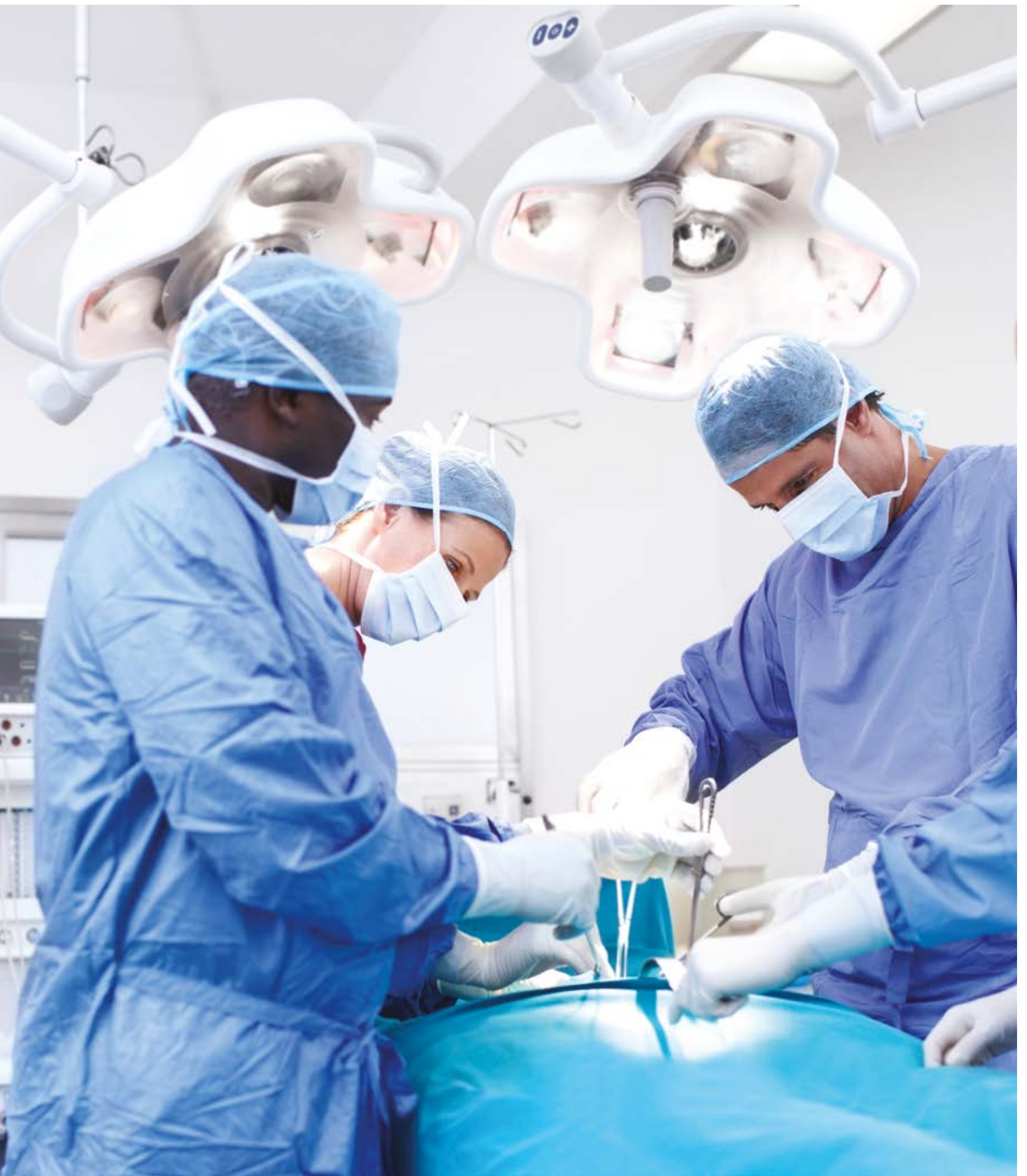

# INSTRUMENT BASKETS

## POLISHED AISI 304 GRADE STAINLESS STEEL

Our instrument baskets come with a perfectly finished top wire which reduces the chance of perforations to a minimum and a lifetime guarantee.

All pictures ©Belintra NV

- Manufactured from highly polished AISI 304 grade stainless steel.
- Continuous quality control throughout the whole production process, guarantees quality and dimensional stability.
- Lifetime guarantee on all instrument baskets.
- Instruments stay firmly in place.
- Designed to prevent perforations in packaging.
- Optimises the full sterilisation process.

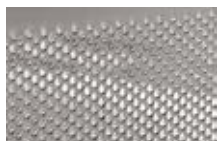

### PUNCH PATTERN

2mm holes guarantee a permeability of over 50%, benefiting the full washing process. Steam and water penetrate during sterilisation and washing. Protective sides guard instruments against damage designed to accommodate ultra fine instruments.

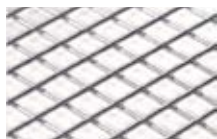

### BASE

Smooth, dry base completely traps any moisture that may stick to the packaging. This ensures that moisture cannot heat up or evaporate under the influence of radiation, convection or conduction.



### QUALITY CONTROL TOOL

For quality-assurance purposes, all our baskets are put through a special quality control tool. To make sure that the mesh is uniform in size, the base of every basket is meticulously checked.

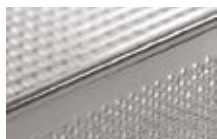

### TOP WIRE

Upper wire is made from plasma welded on to the sides of the basket. This results in a beautifully finished product that is devoid of any sharp edges reducing the risk of perforations during unpacking.



### UNIVERSAL SIZES

DIN and Euro instrument baskets come in universal sizes and fit perfectly into the wire baskets. Instrument baskets are fitted with 2 handles with a load-bearing capacity of 15 kg.



### MATERIAL

Instrument baskets are manufactured from AISI 304 L grade stainless steel and come with an electrolytically polished finish.



### SHAPE

Manufactured so that you will never have to worry about holes or cavities that could harbour bacteria.



### BAR CODE ZONE

For identification and traceability purposes, the instrument baskets are fitted with a bar code zone.







From Sterile Services to Operating Theatre procedure packs are only touched twice enhancing sterility of the pack and greatly reducing Infection risk.



Trolleys and carts are widely used in the transportation of instrument baskets.



Maintaining the highest standards of hygiene across all areas of the sterile services.



**DIN INSTRUMENT BASKETS 60mm HIGH**  
With flat base

Code	L (mm)	W (mm)	H (mm)
MS12250600	120	x 250	x 64
MS24250600	240	x 250	x 64
MS48250600	480	x 250	x 64



**DIN INSTRUMENT BASKETS 100mm HIGH**  
With flat base

Code	L (mm)	W (mm)	H (mm)
MS24251000	240	x 250	x 100
MS48251000	480	x 250	x 100



**EURO INSTRUMENT BASKET 60mm HIGH**  
With flat base

Code	L (mm)	W (mm)	H (mm)
MS12300600	120	x 300	x 64
MS24300600	240	x 300	x 64
MS48300600	480	x 300	x 64



**EURONORM-2 INSTRUMENT BASKET**  
**60mm HIGH**  
With flat base

Code	L (mm)	W (mm)	H (mm)
MS11300600	115	x 320	x 64
MS23300600	230	x 320	x 64
MS46300600	460	x 320	x 64



**FINE MESH INSTRUMENT BASKETS 40mm HIGH LID INCLUDED**  
With flat base

Code	L (mm)	W (mm)	H (mm)
MS24250001	240	x 250	x 40
MS48250001	480	x 250	x 40

# WIRE BASKETS

## HIGHLY POLISHED STAINLESS STEEL

Wire baskets are invaluable if you want to ensure that your sterile sets of instruments are stored safely.  
All pictures ©Belintra NV

- Steel wire basket, in both Euronorm and DIN sizes.
- Safe and hygienic means to transport and store sterile packs.
- Invaluable storage tool in your instrument set sterilisation process.
- Wire baskets can be used in all our CSSD trolleys and storage systems.



### STACKABLE

Without the addition of extra handles, the baskets are stackable, user-friendly and safer for hygiene purposes, the upper edge features a single wire only.



### SAFETY

As the wrapped instrument tray is stored in a wire basket direct contact with the sterile set is avoided.



### OUTSTANDING QUALITY

Baskets have been manufactured in accordance with the most stringent standards. Our baskets are devoid of any sharp edges or welding burrs which could cause tears in packaging.

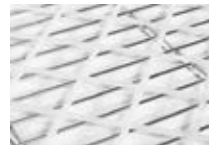

### SILICONE PAD

Used with wire baskets and wire shelves.

Code	L (mm)	W (mm)	H (mm)
MS30100004	540	x 280	x 3
MS30100006	540	x 280	x 6



### EURONORM STAINLESS STEEL WIRE BASKETS

Code	L (mm)	W (mm)	H (mm)
MS60401000	600	x 400	x 100
MS60401300	600	x 400	x 130
MS60402000	600	x 400	x 200
MS40302300	400	x 300	x 100

### DIN STAINLESS STEEL WIRE BASKETS

Code	L (mm)	W (mm)	H (mm)
MS60300400	600	x 300	x 50
MS60300130	600	x 300	x 130

### STAINLESS STEEL STERILISATION BASKET

Code	L (mm)	W (mm)	H (mm)
MS30050012	575	x 280	x 270

# WIRE SHELVES

## CHROME

Highly polished wire trays are the perfect solution if you need to transport and store larger sterilisation packs.

All pictures ©Belintra NV

- Manufactured in accordance with the highest quality
- Used in transport trolleys and storage systems
- Meet the most stringent CSSD and OR requirements



### HANDLES

The wire trays have been fitted with 2 handles that have been seamlessly incorporated into the outer edge. These handles ensure that the wire trays are easy and ergonomic to manipulate.



### ROUNDED STRUCTURE

Our wire trays are devoid of any sharp edges or welding burrs that could cause tears in packaging.



### WELDS

Manufactured in accordance with the highest quality standards.

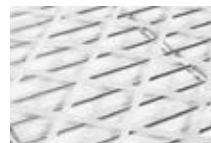

### SILICONE PAD

Used with wire baskets and wire shelves

Code	L (mm)	W (mm)	H (mm)
MS30100004	540	x 280	x 3
MS30100006	540	x 280	x 6



All sterilisation equipment is tested for autoclave pressure chamber use.



### CHROME WIRE SHELVES

Code	L (mm)	W (mm)	H (mm)
MS60300001	600	x 300	x 6/4
MS60400001	600	x 400	x 6/4
MS60600001	600	x 400	x 6/4



### CHROME WIRE SHELVES WITH RAISED EDGE

Code	L (mm)	W (mm)	H (mm)
MS60400002	600	x 400	x 30

# STERILISATION STORAGE

## BAY FRAME - NON RIP STORAGE SYSTEM



**SET-UP EXAMPLE: 1**

Use static or mobile uprights and spacer units.



**Image: 2**

Configure tray runners and shelf types.



**Image: 3**

Expand storage with additional bays of posts and spacer sets.

### A WEALTH OF POSSIBLE COMBINATIONS

- Each run consists of 2 uprights and a spacer set.
- Spacer set comprises of 4 connecting elements - interconnecting with uprights.
- Select from Aluminium, stainless steel or chrome-plated shelves.
- Finish with extension bays to create the correct amount of storage.



Stores, protects and saves costs by preventing ripped sterile packs

### FREE PLANNING SERVICE

To help develop your big or small project.

### DIN TYPE 300mm FACING - 600mm DEEP STORAGE

Static	Mobile	Description	W (mm)	D (mm)	H (mm)
MS0621	MS0621M	Start kit	300	600	2100
MS1300	MS1300	Spacer set	300		

### TRAY RUNNER KIT

Turn click
MS6400

### EURO 400mm FACING - 600mm DEEP STORAGE

Static	Mobile	Description	W (mm)	D (mm)	H (mm)
MS0621	MS0621M	Start kit	300	600	2100
MS1400	MS1400	Spacer set	400		

### TRAY RUNNER KIT

Turn click
MS4600

### EURO 600mm FACING - 400mm DEEP STORAGE

Static	Mobile	Description	W (mm)	D (mm)	H (mm)
MS0421	MS0421M	Start kit	300	400	2100
MS1600	MS1600	Spacer set	600		

### TRAY RUNNER KIT

Turn click
MS4600

### LONG SPAN 600mm DEEP STORAGE

Static	Mobile	Description	W (mm)	D (mm)	H (mm)
MS0621	MS0621M	Start kit	1000	600	2100
MS1900	MS1900M	Spacer set	1000		

### TRAY RUNNER KIT

Turn click
MS6400

### SHELF TYPE - 908 x 626 x 25mm

Aluminium	Chrome-plated
MS904	MS914

- System ensures the best possible use of available space
  - Racks of equal depth can be combined ad infinitum
- All pictures ©Belintra NV

### ACCESSORIES

Code	Description
MS0202	Label holder for post fix
MF0101	Label holder insert
MM0697-6	Open frame on telescopic runners 600 x 400mm
MM0697-4	Open frame on telescopic runners 400 x 600mm
MS2400	Closed frame on telescopic runners 600 x 400mm
MS2401	Closed frame on telescopic runners 400 x 600mm
MS1358	Catheter holder stainless steel



**LABEL HOLDERS**



**OPEN FRAME RUNNERS**



**CLOSED FRAME RUNNERS**



**MOBILE POST CASTORS**



**CATHETER HOLDER**



**ROOF PANELS**



**ANODISED ALUMINIUM**

The construction is completely devoid of welds, guaranteeing a fully hygienic unit.



**TURN AND CLICK RUNNERS**

Injection moulded runners with a unique turn-and-click system to secure without the need for bolts or tools.



**MATERIALS**

Choose from aluminium, stainless steel or chrome-plated wire shelving.



**INSTRUMENT AND WIRE BASKETS**

Please see pages 96 - 99 for full details.

Products to reduce decontamination in operating theatres, clinics and wards.



## STERILE PACKING TABLES

### WORKING PRODUCTS FOR STERILE AREAS

- Hygienic preparation surfaces for wire trays and containers used in surgery.
- 35 x 35mm square section bars and AISI 304 (1.4301) stainless steel.
- Completely smooth Scotch-brite surface finish with rounded corners.
- Facilitating washing, cleaning and disinfection operations for maximum hygiene.

#### EDGING DETAIL

Smooth and hygienic rounded corners - Optional up stand back



#### 900mm TABLE WITHOUT SHELF

Static	Mobile	W (mm)	D (mm)	H (mm)
S1289	S1200	1200	800	900
S1489	S1400	1400	800	900
S1689	S1600	1600	800	900
S1889	S1800	1800	800	900
S2089	S2000	2000	800	900



S1489 shown

#### 900mm TABLE WITH SINGLE FIXED SHELF

Static	Mobile	W (mm)	D (mm)	H (mm)
S0289	S0200	1200	800	900
S0489	S0400	1400	800	900
S0689	S0600	1600	800	900
S0889	S0800	1800	800	900
S0089	S2200	2000	800	900



S0489 shown

# PRACTICAL APPLICATION

STERILISATION - ORGANISATION - TRANSPORTATION



Sterilisation and examination of medical equipment.



Carefully and methodically packed medical equipment on a structurally and hygienically safe work surface.



Fully compatible with all Medstor CSSD trolleys, carts and instrument cabinets.

## 900mm TABLE WITH ADJUSTABLE SHELF

Static	Mobile	W (mm)	D (mm)	H (mm)
S1290	S0290	1200	x 800	x 800-1200
S1490	S0490	1400	x 800	x 800-1200
S1690	S0690	1600	x 800	x 800-1200
S1890	S0890	1800	x 800	x 800-1200
S2090	S0090	2000	x 800	x 800-1200



S1490 shown

# HEIGHT ADJUSTABLE PACKING TABLES

CRANK HAND - MOTORISED SURFACE

- Hygienic preparation surfaces for wire trays and containers used in surgery
- 35 x 35mm square section bars and AISI 304 (1.4301) stainless steel
- Completely smooth Scotch-brite surface finish with rounded corners
- Facilitating washing, cleaning and disinfection operations for maximum hygiene

## HEIGHT ADJUSTABLE

Crank handle from 800 - 1200mm



## 800 - 1200mm CRANK HANDLE HEIGHT ADJUSTABLE TABLES

Static	Mobile	W (mm)	D (mm)	H (mm)
S1280	S0280	1200	x 800	x 800 - 1200
S1480	S0480	1400	x 800	x 800 - 1200
S1680	S0680	1600	x 800	x 800 - 1200
S1880	S0880	1800	x 800	x 800 - 1200
S2880	S0080	2000	x 800	x 800 - 1200



S1480 shown

## 800 - 1200mm MOTORISED HEIGHT ADJUSTABLE TABLES

Static	Mobile	W (mm)	D (mm)	H (mm)
S1288	S0288	1200	x 800	x 800 - 1200
S1488	S0488	1400	x 800	x 800 - 1200
S1688	S0688	1600	x 800	x 800 - 1200
S1888	S0888	1800	x 800	x 800 - 1200
S2088	S0088	2000	x 800	x 800 - 1200



S1288 shown

# STERILE CONTAINERS UN 3291 APPROVED

## MOBILE CUPBOARD TRUCKS

- Meet the hygiene requirements for sterile transportation.
- Transported goods are perfectly protected.
- Isolation doors suitable for DIN/ISO trays.
- Anodised light alloy body with stainless steel supporting shelves.
- All cupboards are designed for disinfection tunnel use.

**ALL MEDSTOR PRODUCTS CARRY A MINIMUM 5 YEAR GUARANTEE**



### STERILE CONTAINERS

All cupboard trucks are designed for washing and disinfection in tunnels.



### DOOR DETAIL

Both the central joints of the door and four corners ensure a tight seal around the cupboard contents.



### POSITIVE ARRESTERS

Stop system for preventing accidental container withdrawal.



### TELESCOPIC SHELF

Stainless steel shelf extends out to give easy access to bin handling.



### 12 & 8 TRAY STERILE CUPBOARD TRUCKS

Code	Capacity	W (mm)	D (mm)	H (mm)
H3165	12 trays - 530 x 325 x 200	1230	710	1585
H3162	8 trays - 530 x 325 x 200	977	710	1585

270° door opening for full access.



### 9 & 6 TRAY STERILE CUPBOARD TRUCKS

Code	Capacity	W (mm)	D (mm)	H (mm)
H1625	9 trays - 600 x 300 x 300	1230	710	1500
H1622	6 trays - 600 x 300 x 300	977	710	1500

270° door opening for full access.





Instrument carts work as part of our sterile materials handling system.

**CASE STUDIES**

Please request any number of CSSD case studies, see how we can take your project from start to completion. [View online: www.medstor.co.uk](http://www.medstor.co.uk)



**INSTRUMENT CARTS WITH RUNNERS**

Code	Capacity	W (mm)	D (mm)	H (mm)
H3150	2 sections - 600 x 400 x 100	1400	710	1785
H3170	2 sections - 600 x 400 x 100	510	765	1575

270° door opening for full access.  
Nylon fibreglass rails with positive arresters.



**INSTRUMENT CARTS WITH SHELVES**

Code	Capacity	W (mm)	D (mm)	H (mm)
H3180	2 sections - 600 x 400 x 100	1400	710	1785

270° door opening for full access.  
Nylon fibreglass rails with positive arresters.



Instrument carts work as part of our sterile materials handling system.

# INSTRUMENT CARTS

MOBILE STAINLESS STEEL UNITS

- Anti-torsion base chassis with stainless steel tubes.
- 160mm fixed, swivel and locking castors with brakes.
- Pyramid roof to facilitate water drainage.
- Doors can be locked in opening position 270° and 255°.

**ALL MEDSTOR PRODUCTS CARRY A MINIMUM 5 YEAR GUARANTEE**



**A: SECURITY**  
Device seal system.

**D: CENTRAL BRAKE**  
Stops all trolley motion - Foot operated.

**B: LOCK**  
Locking bar and closing handle.

**E: DRAWER BAR**  
Assists to direct the trolley safely.

**C: DIRECTIONAL LOCK**  
Which enables the control of each individual wheel to be manoeuvred.

**F: CARD HOLDER**  
A4 sized - clear and simple labelling.

**INTERNAL FRAMES**  
Fit inside the cabinet and lock into place.



# PRACTICAL APPLICATION

## STERILE MATERIALS HANDLING



### STAINLESS STEEL BASE

Extremely strong frame - TIG process, external edge with smoke grey PEHD.



### EASY TO MANOEUVRE

2 fixed & 2 swivel 160mm non marking rubber castors with brakes.



### DOOR OPENING

The doors can be locked open at 270° to allow cleaning of the internal surfaces.



### TRAY TRANSPORTATION

Simple to remove internal frames.



### 3 DIN-NORM COMPARTMENT UNIT

#### Description

600 x 300 container holding columns. Stainless steel guides height adjustable every 110mm.

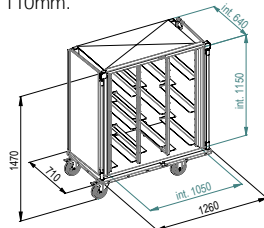

Code S3170



### 2 ISO-NORM COMPARTMENT UNIT

#### Description

600 x 400 container holding columns. 8 pairs of fixed guides every 125mm.

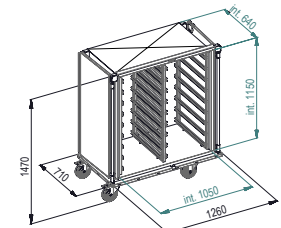

Code S4870



### 2 DIN-NORM COMPARTMENT UNIT

#### Description

600 x 300 container holding columns. 8 pairs of fixed guides every 125mm.

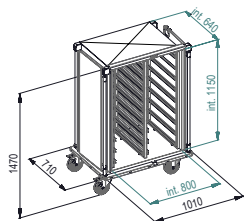

Code S2870



### DOUBLE SHELF UNIT

#### Description

2 removable stainless steel, high density internal shelves.

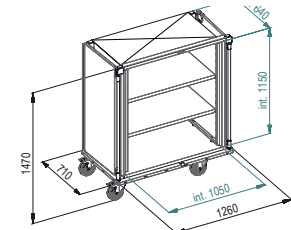

Code S7212



Delivering used or sterilised instruments efficiently to departments.

## INSTRUMENT CABINETS

### MOBILE STERILE STORAGE

- Anti-torsion base chassis with stainless steel tubes.
- 160mm fixed, swivel and locking castors with brakes.
- Pyramid roof to facilitate water drainage.
- Doors can be locked in opening position 270° and 255°.

#### CABINET SET A

##### Description

Compartment equipped with 1 PEHD slides suitable to receive and block 1 x S7101R

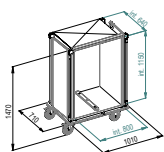

Code S7101

#### CABINET SET B

##### Description

Compartment equipped with 2 PEHD slides suitable to receive and block 1 x S7122R

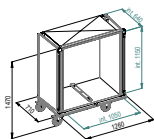

Code S7122

#### CABINET SET C

##### Description

Compartment equipped with 1 PEHD slides suitable to receive and block 1 x S7123R

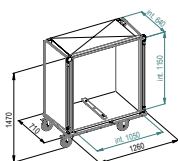

Code S7123

## INSTRUMENT TRANSPORTERS

### INTERNAL FRAMES AND TROLLEYS

- Anti-torsion base chassis with stainless steel tubes.
- All frames and trolleys are autoclave safe.
- Transfer with minimum effort from mobile aluminium units.
- Trolleys specially designed to easily manoeuvre heavy loads.

#### TRANSPORTER FRAME SET A

##### Description

Internal frame for containers and / or DINNORM sized wire trays (600 x 300) designed with a lever system to safely lock to the sides of S7101

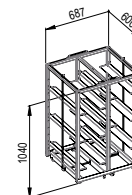

Code S7101R

#### TRANSPORTER FRAME SET B

##### Description

Internal frame for containers and / or ISONORM sized wire trays (600 x 400) designed with a lever system to safely lock to the sides of S7122

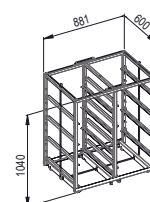

Code S7122R

#### TRANSPORTER FRAME SET C

##### Description

Internal frame for containers and / or DINNORM sized wire trays (600 x 300) designed with a lever system to safely lock to the sides of S7123

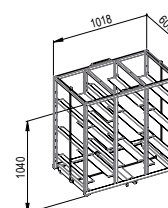

Code S7123R

#### PACKING TABLE

Instrument baskets are placed inside the internal DIN NORM or ISO NORM frame.



#### ORGANISATION

Internal frames are manoeuvred then secured into place using a loading trolley.



#### LOGISTICS

Instrument cabinets are transported to the correct location.



#### READY FOR USE

Stored securely or used in operating theatres.



## INSTRUMENT TROLLEY

### STERILE MOBILE UNITS

- Stainless steel tubes.
- 160mm fixed, swivel and locking castors with brakes.
- Fitted with PEHD bumpers.

#### TROLLEY SET A

##### Description

Loading/unloading trolley for use with S7101R from cabinet S7101

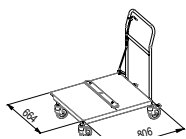

Code S7101T

## DEPOSIT PLATFORMS

### FOR USE WITH STERILE MOBILE UNITS

- Stainless steel construction.
- Robot welded TIG process with perfectly rounded edges.
- All frames are autoclave safe.
- Self levelling feet for uneven floor surfaces.

#### PLATFORM SET A

##### Description

Fixed deposit platform for 1 mod. S7101

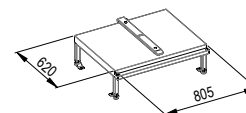

Code S7101P

#### TROLLEY SET B

##### Description

Loading/unloading trolley for use with S7122R from cabinet S7122

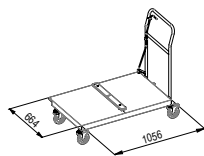

Code S7122T

#### PLATFORM SET B

##### Description

Fixed deposit platform for 1 mod. S7122

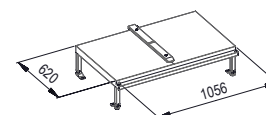

Code S7122P

#### TROLLEY SET C

##### Description

Loading/unloading trolley for use with S7123R from cabinet S7123

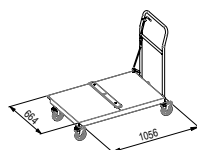

Code S7123T

#### PLATFORM SET C

##### Description

Fixed deposit platform for 1 mod. S7123

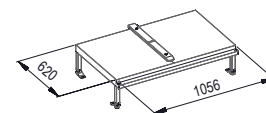

Code S7123P



Please contact us for any additional CSSD logistics requirements.

# STERILE LOGISTICS

## RACKING, TRANSPORTER AND TROLLEY

- AISI 304 Stainless steel.
- One piece fully welded frames.
- Choice of Din and ISO norms.
- 100mm anti-static castors.

**INSTRUMENT AND WIRE BASKETS**  
Please see pages 96 - 99 for full details.



S6312 shown

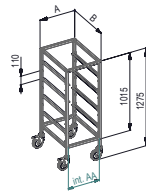

S6412 shown

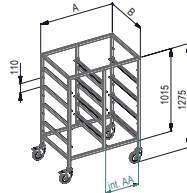

S6812 shown

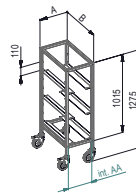

S6312 shown

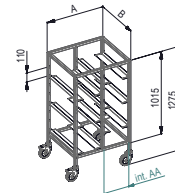

S6612 shown

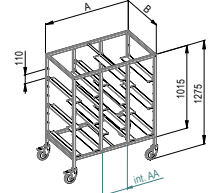

S6112 shown

### MOBILE RACKING WITH 3 STAINLESS STEEL SHELVES

Code	Suitable for	W (mm)	D (mm)	H (mm)
S6412	600 x 400 ISO NORM	453	600	1275
S6812	600 x 400 ISO NORM	881	600	1275
S6312	600 x 300 DIN NORM	356	600	1275
S6612	600 x 400 DIN NORM	687	600	1275
S6112	600 x 400 DIN NORM	1018	600	1275

Shelves are adjustable every 110mm.

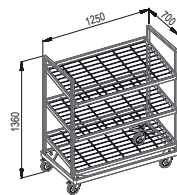

S1271 Dimensions

### CLEANING TROLLEY

Code	Description
S1271	Sterilisation containers cleaning trolley.

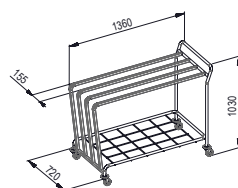

### SHEET TRANSPORTER

Code	Description
S1371	For storage and transportation of sheets to be used for packing trays containing instruments for sterilisation.



# BASKET TRANSPORTERS

## OPERATING ROOM FURNITURE

- AISI 304 stainless steel.
- One piece fully welded frame.
- Stainless steel hook on system.
- Matching accessories.
- 75mm castors with brake.

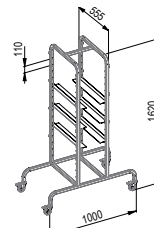

DF2M4 Dimensions

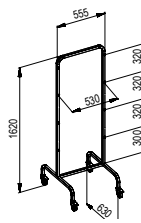

DF4 Dimensions

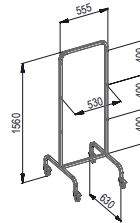

DF3 Dimensions

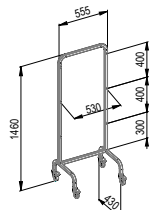

MF3 Dimensions



DF2M4 shown with optional wire baskets



S5615 shown



S5414 shown

### BASKET TRANSPORTER

Code	Description
S1016	8 total 4 on 2 sides
S5616	8 total 6 on 2 sides
S5615	6 total 3 on 3 sides
S5414	3 total 3 on 1 side

### WIRE BASKET

Code	Description
WB1	575 x 275 x 130 basket
WB2	575 x 275 x 260 basket
WB3	575 x 275 x 260 basket with cut out front

### ACCESSORIES

Code	Description
S448021	Urine bottle holder
S448022	Catheter holder
S448024	Bedpan holder
S448025	Shoe holder



S448021 shown



S448022 shown



S448024 shown



S448025 shown



# SURGICAL TABLES

## MAYO TABLES & BOWL STANDS

- AISI 304 Stainless Steel
- Fixed shelf/Removable shelf
- Swivelling shelf and Central shelf options
- Swivel and braked casters
- Foot pump height adjustment
- Smooth clean surfaces



### FIXED SHELF - HEIGHT ADJUSTABLE INSTRUMENT STAND

Code	W (mm)	D (mm)	H (mm)	Description
MS96581	660	540	880 - 1220	Fixed shelf unit
MS97481	700	450	880 - 1220	Fixed shelf unit
MS96481	600	400	880 - 1220	Fixed shelf unit

### SWIVEL SHELF - HEIGHT ADJUSTABLE INSTRUMENT STAND

Code	W (mm)	D (mm)	H (mm)	Description
MS96541	660	540	880 - 1220	Swivelling top unit
MS97451	700	450	880 - 1220	Swivelling top unit
MS96401	600	400	880 - 1220	Swivelling top unit



MS9748 shown



MS9745 shown

- Mobile unit with swivel castors
- Fully hygienic work surfaces
- Smooth rounded edge table top

### CENTRAL TOP - HEIGHT ADJUSTABLE INSTRUMENT STAND

Code	W (mm)	D (mm)	H (mm)	Description
MS9660	660	540	880 - 1220	Central top unit
MS9778	700	450	880 - 1220	Central top unit
MS9764	600	400	880 - 1220	Central top unit

### MANUAL ADJUSTMENT - INSTRUMENT STAND

Code	W (mm)	D (mm)	H (mm)	Description
MS9757	660	540	740 - 1170	Manual adjustment
MS9747	700	450	740 - 1170	Manual adjustment
MS9647	600	400	740 - 1170	Manual adjustment



MS9778 shown



MS9747 shown

- Swivel anti-static castors
- Fully hygienic stainless steel surfaces
- Smooth edge design

### BOWL STANDS

Code	W (mm)	D (mm)	H (mm)	Description
MS9704	600	600	850	Single bowl
MS9705	700	700	850	Double bowl

### SWIVELLING MOBILE BOWLS

Code	W (mm)	D (mm)	Litres	Description
MS9706	320	320	5	Base mounted
MS9707	600	600	8	Base mounted



MS9704 shown



MS9705 shown



MS9706 & MS9707 shown



## STERILE LOGISTICS

### CLOG HOLDER & SURGICAL STEPS

- No join - TIG welded manufacturing.
- Anti-static 100mm castors with four ring buffers - 2 braked.
- Lightweight and easy to manoeuvre.

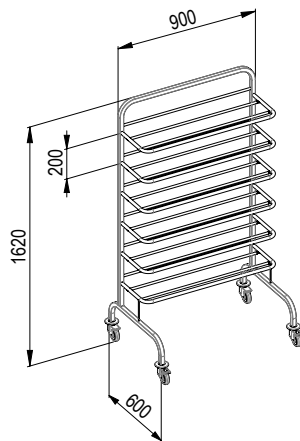

#### 24 PAIR CLOG HOLDER MOBILE CART

Code	W (mm)	D (mm)	H (mm)	Description
MS9600	900	600	1620	Hold up to 24 pairs of operating room clogs

#### SURGICAL STEPS

- AISI 304 Stainless steel structure
- Removable steps



Code	W (mm)	D (mm)	H (mm)	Description
MS9701	600	350	130	Single step
MS9702	600	350	220	Single step
MS9703	600	350/680	220/440	Double step
MS9701S	400	300	150	Single step

# EURO NORM STERILE LOGISTICS

## DRESSING TROLLEYS

- AISI 304 Stainless steel.
- Fully welded frame.
- Swivel & braked castors.
- All standard dressing trolley options available to 600 x 400 top dimensions.
- Shelves fixed and/or removable.
- Three edges up one down or recessed shelves on request.

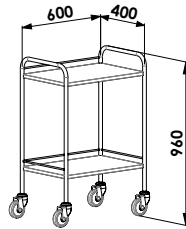

### STAINLESS STEEL TROLLEY WITH HANDLE

Code	Description
S6401	2 recessed shelves with inbuilt handles.

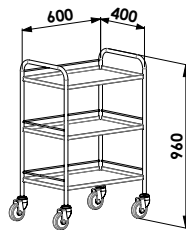

### STAINLESS STEEL TROLLEY WITH HANDLE - 2 SHELVES

Code	Description
S6402	3 recessed shelves with inbuilt handles.

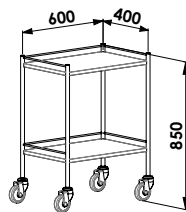

### STAINLESS STEEL TROLLEY WITH RAIL

Code	Description
S6403	2 recessed shelves with inbuilt handles.



# STOOL SEATING

HEIGHT ADJUSTABLE SADDLE SEATING  
CE Marked

- Ergonomic, heavy duty seating.
- Lightweight frame, comfortable seat pad.
- Robust aluminium 5 star base with castors.
- Anti-static fully mobile base.
- Used in operating theatres and laboratories.

**ALL MEDSTOR PRODUCTS CARRY A MINIMUM 5 YEAR GUARANTEE**

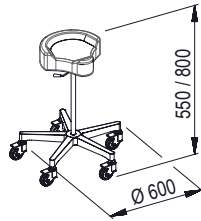

## PNEUMATIC SADDLE SEAT STOOL - 550/800mm HIGH

Code	Description
S9807	Pneumatic gas raising height adjustable seat, fitted with non marking castors.
S947908	Optional back rest
S947910	Adjustable arms
S947912	Foot-brake

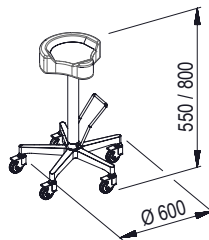

## HYDRAULIC SADDLE SEAT STOOL - 550/800mm HIGH

Code	Description
S9806	Hydraulic raising padded seat stool with non marking castors.
S947908	Optional back rest
S947910	Adjustable arms
S947912	Foot-brake

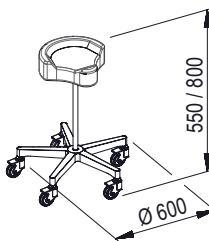

## SADDLE SEAT STOOL - 550/800mm HIGH

Code	Description
S9805	Padded seat, height adjustable via screw fitting. Fitted with non marking castors.
S947908	Optional back rest
S947910	Adjustable arms
S947912	Foot-brake

Technical seating certified for disinfection room environments.







## HTM 71 MATERIALS HANDLING

MODULE CARTS & PROCEDURE TROLLEYS

# BEST IN CLASS

Flexibility in design, specification and style, multifunctional mobile units compatible with all Medstor trays for maximum organisation. Customise for purpose with working accessories.

## MODULE CARTS

BEDSIDE, RESUS, ISOLATION,  
EPIDURAL, ANAESTHESIA...

MedStar

High Pressure Laminate, Moisture Resistant MDF or  
Waterproof Polymer Construction Board Encased  
in Anodised Aluminium Profiles for a Heightened  
Hygienic Solution.

### BOARD OR POLYMER:-

High pressure laminate, moisture resistant MDF or  
Waterproof Polymer Construction board encased  
in anodised aluminium profiles for a heightened  
hygienic solution.





## BUILD TO YOUR SPECIFICATION

Module Carts accept the full Medstor tray and divider system, lightweight and robust they provide hygienic working surfaces and protect their contents. Offering inbuilt system organisation and product identification.

**COLOUR PALETTE OPTIONS:** Additional options available on request.

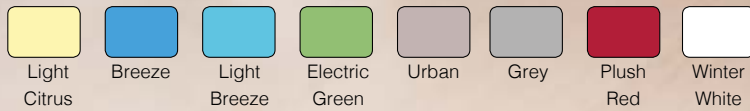

**MC6500-060:**



### FULLY WELDED BASE FRAME:

Extremely strong yet light weight frame design with lightweight anodised aluminium uprights in a selection of colours.



### EASY TO MANOEUVRE:

Tente 125mm swivel, braked and antistatic castor, buffered wheels with locking brakes.



### CHOICE OF DRAWER DEPTHS:

Built to house the Medstor trays and dividers supplied in 50, 100 and 200mm heights.



### TRAY TRANSPORTATION:

Trays can simply be transferred from modular cart to any Medstor liner storage systems.

## BUILD YOUR OWN - CART CONFIGURATOR

19 total drawer fixing points available -

Tray size	Requires
50mm	2 drawer fixing points
100mm	3 drawer fixing points
200mm	5 drawer fixing points

### E.G: MC6500-060 (As main image)

6 x 100mm trays	3 fixing points =
<b>Total fixing</b>	<b>18 points used</b>

### EG: MC6500-122 (Inset image)

1 x 50mm tray	2 fixing points +
2 x 100mm trays	6 fixing points +
2 x 200mm trays	10 fixing points =
<b>Total fixing</b>	<b>18 points used</b>



## DRAWER FRONT MODULE CART 730 x 530 x 1160mm

Code	Description
MC6500-060	6 x 100mm trays
MC6500-013	1 x 100mm trays 3 x 200mm trays
MC6500-032	3 x 100mm trays 2 x 200mm trays
MC6500-122	1 x 50mm tray 2 x 100mm trays 2 x 200mm trays
MC6500-231	2 x 50mm trays 3 x 100mm trays 1 x 200mm tray

### MC6500-122:

See page 124 for full range of cart accessories.

# MODULE ROLLER SHUTTER CARTS

BEDSIDE, RESUS, ISOLATION, EPIDURAL, ANAESTHESIA...

Push button and code lock security feature for all  
Module Carts see page 125 for details.





## MODULE ROLLER CARTS

**E23 ultrasonic welded slat shutter in light grey as standard caddy braking system applied to the coil.**



### FULLY WELDED BASE FRAME:

Extremely strong yet light weight frame design with lightweight anodised aluminium uprights in a selection of colours.



### EASY TO MANOEUVRE:

Tente 125mm swivel, braked and antistatic castor, buffered wheels with locking brakes.



### CHOICE OF DRAWER DEPTHS:

Built to house the Medstor trays and dividers supplied in 50, 100 and 200mm heights.



### TRAY TRANSPORTATION:

Trays can simply be transferred from modular cart to any Medstor liner storage systems.

## BUILD YOUR OWN - CART CONFIGURATOR

1200 high - 15 total fixing points available

1450 high - 20 total fixing points available

1750 high - 26 total fixing points available

Tray size	Requires
50mm	2 drawer fixing points
100mm	3 drawer fixing points
200mm	5 drawer fixing points

### EG: MC7507-0133 (Inset image)

1 x 50mm tray	2 fixing points +
3 x 100mm trays	9 fixing points +
3 x 200mm trays	15 fixing points =
<b>Total fixing</b>	<b>26 points used</b>

**MC7507-0133:** 1750 high module roller cart - inset back

**MC7500:** 1200 high module roller cart - Inset front



### MOBILE ROLLER SHUTTER 730 x 530 x 1200mm

Code	Description
MC7500-0000	Trolley only
MC7500-0050	5 x 100mm trays
MC7500-0031	3 x 100mm trays 1 x 200mm trays
MC7500-0003	3 x 200mm trays

### MOBILE ROLLER SHUTTER 730 x 530 x 1450mm

Code	Description
MC7504-0000	Trolley only
MC7504-0160	1 x 50mm tray 6 x 100mm trays
MC7504-0032	3 x 100mm trays 2 x 200mm trays
MC7504-0113	1 x 50mm tray 1 x 100mm trays 3 x 200mm trays

### MOBILE ROLLER SHUTTER 730 x 530 x 1750mm

Code	Description
MC7507-0000	Trolley only
MC7507-0180	1 x 50mm tray 8 x 100mm trays
MC7507-0133	1 x 50mm tray 3 x 100mm trays 3 x 200mm trays
MC7507-0024	2 x 100mm trays 4 x 200mm trays

# CUSTOMISE WITH ACCESSORIES

## ADAPTING FOR CHANGING HEALTHCARE DEMANDS

- Accessories can be retro fitted with many fitting simply to the rail
- Secure yet simple to remove for deep hygienic cleaning



**ADJUSTABLE HANDLE**  
Code: MM4479A



**ADJUSTABLE ACCESSORY RAIL**  
Code: MM4479B



**GLOVE BOX HOLDER**  
Code: MM4479C



**CONTAINER BRACKET**  
Code: MM4479D



**STERILE GEL HOLDER**  
Code: MM4479E



**FILE HOLDER**  
Code: MM4479F

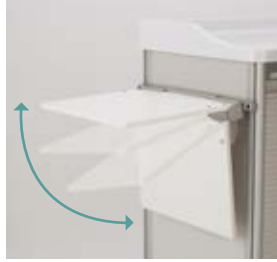

**DROP DOWN WORKTOP EXT**  
Code: MM4479G



**ADJUSTABLE HOOK**  
Code: MM4479H

Project co-ordinators will ensure delivery to your exact requirements.

- Sample demonstration carts.
- Full testing certification and standards.
- Colour finish swatches.



**IV POLE**  
Code: MM4479I



**AIRWAY / BOUGIE HOLDER**  
Code: MM4479J



**TILT BINS**  
4 Bins: MM4479K4  
5 Bins: MM4479K5



**PC / I.T. ARM**  
Code: MM4479L



**DEFIBRILLATOR PLATFORM**  
Code: MM4479M



**TABLET HOLDER**  
Code: MM4479N



**O2 HOLDER**  
Code: MM4479P

**CHART BOARD HOLDER**  
Code: MM44790014



# YOUR SECURITY MATTERS

## INDUSTRY LEADING MODULE CART SECURITY



### CODE SECURITY PAD

Keyless code pad opens all drawers with quick release button

**Code:** Locking 1



### PROXIMITY FOB

Unlocks / locks all drawers when pressed against the release button

**Code:** Locking 2



### KEY LOCKING

Suited claw lock key option - Key opens all drawers

**Code:** Locking 3

- Additional security locking options.
- Units can be fitted with digital or master key security.
- Locking bars protect against unauthorised access.
- Security seals and outer cabinet identification.
- Stickers available on request.



Equip for purpose, embellish for style and transform your environment.

Wide range of finish options available -  
Please request physical board colour samples



Designed and manufactured in the UK by Medstor giving us total system control.

# PROCEDURE TROLLEYS

10 YEAR GUARANTEE ON FULLY WELDED FRAME



## FULLY WELDED FRAME

Extremely strong yet light weight frame design with a choice of colours.

## EASY TO MANOEUVRE

4 100mm castors with non marking, buffered wheels with locking brakes.

## ORGANISATION

Built to house the Medstor tray and divider system supplied in a section of sizes.

## EASY TO CLEAN

Removable trays and liners with tough ABS top section, seamless side panels.

## CONFIGURED AND ACCESSORISED TO SUIT ALL APPLICATIONS TRAYS SUPPLIED WITH LENGTH WAY AND WIDTH WAY DIVIDERS

Compact tray 400 x 300mm 1 off each.

Euro tray 600 x 400mm 2 off each.

Crystal clear, shatterproof Medstor polycarbonate trays, available in three depths 50mm, 100mm and 200mm (max load per tray 15kgs).

## RAILS ON BOTH SIDE OF THE TROLLEY TO HOLD ACCESSORIES SUPPLIED WITH A TOUGH RECESSED SEAMLESS ACRYLIC CAPPED ABS TOP OPTIONAL STAINLESS STEEL TOPS INCLUDES MOULDED LINER SIDES

Include arresters to prevent accidental tray withdrawal

## LOCKABLE DOORS AND BACK PANELS AVAILABLE



# 850mm LOW LEVEL

## COMPACT DISCREET STORAGE SOLUTION

- One piece fully welded frame with a 10 year guarantee.
- Choice of tray configurations (All trolleys are supplied with trays and dividers).
- 100mm castors with four ring buffers - 2 braked.
- Easy to clean - removable sides, top and back seamless panels.

### COMPACT TRAY 400 x 300mm CONTAINS:

1 lengthway and widthway divider.  
2 label holders and 10 coloured inserts in 5 colours.

### EURO TRAY 600 x 400mm CONTAINS:

2 lengthway and widthway dividers.  
2 label holders and 10 coloured inserts in 5 colours.

**POLYCARBONATE & ABS TRAYS AVAILABLE IN 50mm, 100mm & 200mm SIZES:** See pages 18-23



**FRAME COLOUR OPTIONS:** Lilac available from stock



**LOW LEVEL COMPACT SINGLE - 468 x 405 x 850mm**

Code	Description
MH1103-0000	Trolley only
MH1103-0040	4 x 100mm trays
MH1103-0031	3 x 100mm trays 1 x 200mm tray
MH1103-0012	1 x 100mm tray 2 x 200mm trays
MH1103-0230	2 x 50mm trays 3 x 100mm trays



**LOW LEVEL EURO SINGLE - 668 x 405 x 850mm**

Code	Description
MH1106-0000	Trolley only
MH1106-0040	4 x 100mm trays
MH1106-0031	3 x 100mm trays 1 x 200mm tray
MH1106-0012	1 x 100mm trays 2 x 200mm trays
MH1106-0230	2 x 50mm trays 3 x 100mm trays



**LOW LEVEL COMPACT DOUBLE - 911 x 405 x 850mm**

Code	Description
MH1203-0000	Trolley only
MH1203-0080	8 x 100mm trays
MH1203-0062	6 x 100mm trays 2 x 200mm trays
MH1203-0024	2 x 100mm trays 4 x 200mm trays
MH1203-0460	4 x 50mm trays 6 x 100mm trays



**LOW LEVEL EURO DOUBLE - 911 x 600 x 850mm**

Code	Description
MH1206-0000	Trolley only
MH1206-0080	8 x 100mm trays
MH1206-0062	6 x 100mm trays 2 x 200mm trays
MH1206-0024	2 x 100mm trays 4 x 200mm trays
MH1206-0460	4 x 50mm trays 6 x 100mm trays

### ACCESSORIES

Description	Stainless steel	Painted colour
90-130mm Adjustable glove box Dim. 90 x 110 x 110mm.	MM4479CSS	MM4479CPL
Sharps bin holder - Up to 7 litre capacity.	MM4479DSS	MM4479DPL
Polymer sharps bin holder		MM4479R
Gel holder Dim. 90 x 110 x 110mm.	MM4479ESS	MM4479EPL
File holder - Accepts A4 soft and hard back files - Dim. 290 x 300 x 100mm.	MM4479FSS	MM4479FPL
Drop down shelf - Hinged work surface extension, fits to right hand side of the trolley. 380 x 290mm.	MM4479GSS	MM4479GPL
Oxygen carrier - Adjustable secure bottle grip	MMS4479PSS	MMS4479PPL



**ADJUSTABLE GLOVE BOX**



**SHARPS BIN HOLDER**



**GEL HOLDER**



**A4 FILE HOLDER**

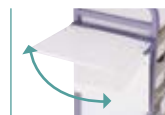

**DROP DOWN HINGED SHELF**



**BOTTLE HOLDER**



Fits perfectly under workbench units for discrete trolley storage.





Ideal for scribing procedures  
The fixed handles provide balanced handling

**COMPACT TRAY 400 x 300mm CONTAINS:**

- 1 lengthway and widthway divider.
- 2 label holders and 10 coloured inserts in 5 colours.

**EURO TRAY 600 x 400mm CONTAINS:**

- 2 lengthway and widthway dividers.
- 2 label holders and 10 coloured inserts in 5 colours.



Possibly the most important aspect of effective materials management is a clear no fuss identification label. Available in credit card size or half size the labels can be fitted landscape or portrait both on the tray or rim with a specialised clip.

# 1050mm HIGH WITH HANDLES

## EVERYDAY USE ON BUSY HOSPITAL WARDS

- One piece fully welded frame with a 10 year guarantee.
- Choice of tray configurations (All trolleys are supplied with trays and dividers).
- 100mm castors with four ring buffers - 2 braked.
- Easy to clean - removable sides, top and back seamless panels.



**STANDARD HEIGHT WITH HANDLES**  
**COMPACT SINGLE 468 x 405 x 1050mm**

Code	Description
MH3103-0000	Trolley only
MH3103-0050	5 x 100mm trays
MH3103-0031	3 x 100mm trays 1 x 200mm tray
MH3103-0003	3 x 200mm trays
MH3103-0112	1 x 50mm tray 1 x 100mm tray 2 x 200mm trays
MH3103-0320	3 x 50mm trays 2 x 100mm trays



**STANDARD HEIGHT WITH HANDLES**  
**COMPACT DOUBLE 911 x 405 x 1050mm**

Code	Description
MH3203-0000	Trolley only
MH3203-0010	10 x 100mm trays
MH3203-0062	6 x 100mm trays 2 x 200mm trays
MH3203-0006	6 x 200mm trays
MH3203-0224	2 x 50mm trays 2 x 100mm trays 4 x 200mm trays
MH3203-0640	6 x 50mm trays 4 x 100mm tray

**POLYCARBONATE & ABS TRAYS AVAILABLE IN 50mm, 100mm & 200mm SIZES:** See pages 18-23



**FRAME COLOUR OPTIONS:** Lilac available from stock



**STANDARD HEIGHT WITH HANDLES**  
**SINGLE EURO 668 x 405 x 1050mm**

Code	Description
MH3106-0000	Trolley only
MH3106-0050	5 x 100mm trays
MH3106-0031	3 x 100mm trays 1 x 200mm trays
MH3106-0003	3 x 200mm trays
MH3106-0112	1 x 50mm trays 1 x 100mm trays 2 x 200mm trays
MH3106-0320	3 x 50mm trays 2 x 100mm trays



**STANDARD HEIGHT WITH HANDLES**  
**EURO DOUBLE 911 x 600 x 1050mm**

Code	Description
MH3206-0000	Trolley only
MH3206-0010	10 x 100mm trays
MH3206-0062	6 x 100mm trays 2 x 200mm trays
MH3206-0006	6 x 200mm trays
MH3206-0224	2 x 50mm trays 2 x 100mm trays 4 x 200mm trays
MH3206-0640	6 x 50mm trays 4 x 100mm trays

### ACCESSORIES

Description	Stainless steel	Painted colour
90-130mm Adjustable glove box Dim. 90 x 110 x 110mm.	MM4479CSS	MM4479CPL
Sharps bin holder - Up to 7 litre capacity.	MM4479DSS	MM4479DPL
Polymer sharps bin holder		MM4479R
Gel holder Dim. 90 x 110 x 110mm.	MM4479ESS	MM4479EPL
File holder - Accepts A4 soft and hard back files - Dim. 290 x 300 x 100mm.	MM4479FSS	MM4479FPL
Drop down shelf - Hinged work surface extension, fits to right hand side of the trolley. 380 x 290mm.	MM4479GSS	MM4479GPL
Oxygen carrier - Adjustable secure bottle grip	MMS4479PSS	MMS4479PPL



**ADJUSTABLE GLOVE BOX**



**SHARPS BIN HOLDER**



**GEL HOLDER**



**A4 FILE HOLDER**

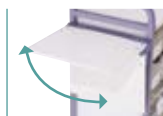

**DROP DOWN HINGED SHELF**



**BOTTLE HOLDER**

# 950mm STANDARD HEIGHT

## TRANSFER FROM CART TO STORAGE SYSTEMS

- One piece fully welded frame with a 10 year guarantee.
- Choice of tray configurations (All trolleys are supplied with trays and dividers).
- 100mm castors with four ring buffers - 2 braked.
- Easy to clean - removable sides, top and back panels.

### COMPACT TRAY 400 x 300mm CONTAINS:

1 lengthway and widthway divider.  
2 label holders and 10 coloured inserts in 5 colours.

### EURO TRAY 600 x 400mm CONTAINS:

2 lengthway and widthway dividers.  
2 label holders and 10 coloured inserts in 5 colours.

**POLYCARBONATE & ABS TRAYS AVAILABLE IN**  
50mm, 100mm & 200mm SIZES: See pages 18-23



**FRAME COLOUR OPTIONS:** Lilac available from stock



**STANDARD HEIGHT COMPACT SINGLE 468 x 405 x 950mm**

Code	Description
MH2103-0000	Trolley only
MH2103-0050	5 x 100mm trays
MH2103-0031	3 x 100mm trays 1 x 200mm tray
MH2103-0003	3 x 200mm trays
MH2103-0112	1 x 50mm tray 1 x 100mm tray 2 x 200mm trays
MH2103-0320	3 x 50mm trays 2 x 100mm trays



**STANDARD HEIGHT SINGLE EURO 668 x 405 x 950mm**

Code	Description
MH2106-0000	Trolley only
MH2106-0050	5 x 100mm trays
MH2106-0031	3 x 100mm trays 1 x 200mm tray
MH2106-0003	3 x 200mm trays
MH2106-0112	1 x 50mm trays 1 x 100mm tray 2 x 200mm trays
MH2106-0320	3 x 50mm trays 2 x 100mm trays



**STANDARD HEIGHT COMPACT DOUBLE 911 x 405 x 950mm**

Code	Description
MH2203-0000	Trolley only
MH2203-0010	10 x 100mm trays
MH2203-0062	6 x 100mm trays 2 x 200mm trays
MH2203-0006	6 x 200mm trays
MH2203-0224	2 x 50mm trays 2 x 100mm trays 4 x 200mm trays
MH2203-0640	6 x 50mm trays 4 x 100mm trays



**STANDARD HEIGHT EURO DOUBLE 911 x 600 x 950mm**

Code	Description
MH2206-0000	Trolley only
MH2206-0010	10 x 100mm trays
MH2206-0062	6 x 100mm trays 2 x 200mm trays
MH2206-0006	6 x 200mm trays
MH2206-0224	2 x 50mm trays 2 x 100mm trays 4 x 200mm trays
MH2206-0640	6 x 50mm trays 4 x 100mm trays

### ACCESSORIES

Description	Stainless steel	Painted colour
90-130mm Adjustable glove box Dim. 90 x 110 x 110mm.	MM4479CSS	MM4479CPL
Sharps bin holder - Up to 7 litre capacity.	MM4479DSS	MM4479DPL
Polymer sharps bin holder		MM4479R
Gel holder Dim. 90 x 110 x 110mm.	MM4479ESS	MM4479EPL
File holder - Accepts A4 soft and hard back files - Dim. 290 x 300 x 100mm.	MM4479FSS	MM4479FPL
Drop down shelf - Hinged work surface extension, fits to right hand side of the trolley. 380 x 290mm.	MM4479GSS	MM4479GPL
Oxygen carrier - Adjustable secure bottle grip	MMS4479PSS	MMS4479PPL



**ADJUSTABLE GLOVE BOX**



**SHARPS BIN HOLDER**



**GEL HOLDER**



**A4 FILE HOLDER**

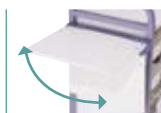

**DROP DOWN HINGED SHELF**



**BOTTLE HOLDER**



Our high capacity mobile storage units are easy to manoeuvre.

**FRAME COLOUR OPTIONS:** Lilac available from stock



MH4206-0284 shown

## 1450mm TALL TROLLEY

### HIGH VOLUME PRODUCT MOBILITY

- One piece fully welded frame with a 10 year guarantee.
- Choice of tray configurations (All trolleys are supplied with trays and dividers).
- 100mm castors with four ring buffers - 2 braked.
- Easy to clean - removable sides, top and back seamless panels.



**TALL TROLLEY SINGLE EURO 668 x 405 x 1450mm**

Code	Description
MH4106-0000	Trolley only
MH4106-0080	8 x 100mm trays
MH4106-0033	3 x 100mm trays 3 x 200mm trays
MH4106-0014	1 x 100mm trays 4 x 200mm trays
MH4106-0142	1 x 50mm trays 4 x 100mm trays 2 x 200mm trays
MH4106-0052	5 x 100mm trays 2 x 200mm trays
MH4106-0005	5 x 200mm trays



**TALL TROLLEY DOUBLE EURO 911 x 600 x 1450mm**

Code	Description
MH4206-0000	Trolley only
MH4206-0916	16 x 100mm trays
MH4206-0066	6 x 100mm trays 6 x 200mm trays
MH4206-0028	2 x 100mm trays 8 x 200mm trays
MH4206-0284	2 x 50mm trays 8 x 100mm trays 4 x 200mm trays
MH4206-0014	10 x 100mm trays 4 x 200mm trays
MH4206-0001	10 x 200mm trays

# DISTRIBUTION CARTS

## ALUMINIUM FRAME MODULAR CONFIGURATIONS



Code H35500600



Code H35160000



Code H35509600



### WELDED FRAME

A strong frame design with a choice of colours.



### HINGED DOORS

Laminated front opening doors.



### ORGANISATION

Built to house the Medstor tray and divider system supplied in a selection of sizes.



### CENTRAL LOCK

Simultaneously lock or unlock both doors.

### CONFIGURE TRAYS WITH LENGTH WAY AND WIDTH WAY DIVIDERS -

Euro tray 600 x 400mm 2 off each.

Clear crystal, shatter proof Medstor polycarbonate trays, available in three depths 50mm, 100mm and 200mm (max load per tray 15kgs).

Trays not included please see page 18-23 for additional information

### DISTRIBUTION CARTS -

Code	W (mm)	D (mm)	H (mm)
H35500600	740 x	535 x	1000
H35160000	740 x	535 x	1190
H35509600	740 x	535 x	1440



# DISTRIBUTION & DRESSING TROLLEYS

AISI 304 STAINLESS STEEL

Multi-purpose mobile trolleys -  
Lightweight, easy to manoeuvre.

- Fully welded frame.
- Fixed or removable shelves.
- Easy to clean.
- Conforms to ward and surgical theatre standards.
- Options to accessories.

## TROLLEY WITH HANDLE RAIL - (MAIN IMAGE)

Code	Description
MS3103-HD	Heavy duty stainless steel trolley
MS3103-LD	Light duty stainless steel trolley



## STAINLESS STEEL DRESSING TROLLEY 460 x 460 x 890mm

Code	Description		
MS4401	Removable shelves	3 x flanges up	1 x flange down
MS4402	Fixed shelves	3 x flanges up	1 x flange down
MS4403	Removable shelves	Flanges down	
MS4404	Fixed shelves	Flanges down	
MS4405	Removable shelves	Flanges up	



MS4401B shown with buffers

## STAINLESS STEEL DRESSING TROLLEY 610 x 460 x 890mm

Code	Description		
MS6401	Removable shelves	3 x flanges up	1 x flange down
MS6402	Fixed shelves	3 x flanges up	1 x flange down
MS6403	Removable shelves	Flanges down	
MS6404	Fixed shelves	Flanges down	
MS6405	Removable shelves	Flanges up	



MS6401 shown



MS9402 shown

## STAINLESS STEEL DRESSING TROLLEY 920 x 460 x 890mm

Code	Description		
MS9402	Fixed shelves	3 x flanges up	1 x flange down
MS9404	Fixed shelves	Flanges down	

## STAINLESS STEEL DRESSING TROLLEY 1220 x 460 x 890mm

Code	Description		
MS1402	Fixed shelves	3 x flanges up	1 x flange down
MS1404	Fixed shelves	Flanges down	



MS1402 shown



MS1602 shown

## STAINLESS STEEL DRESSING TROLLEY 1220 x 610 x 890mm

Code	Description		
MS1602	Fixed shelves	3 x flanges up	1 x flange down
MS1604	Fixed shelves	Flanges down	

### ACCESSORIES:

Customise the trolley design by suffixing the accessories codes.



Code	Description
B	Protective buffers
BC	Braked castors
SD	Single drawer
SDL	Single drawer with lock

Code	Description
DD	Double drawer
DDL	Double drawer with lock
GR	Guide rail
IV	IV pole

### E.G: MS4401BBC

Dressing trolley, protective buffers and braked castors.

## TECHNOLOGY

RFID SYSTEM - MOBILE I.T. UNITS - SECURITY SYSTEMS

## IMPROVE WORK FLOW

We offer a large number of technology solutions for different areas of the healthcare sector, helping to improve efficiency by speeding up processes in the workplace and decreasing costs.

Mobility is a key benefit recognised by our new offering of mobile computer units along with our tried and tested Smartkanban materials management options.





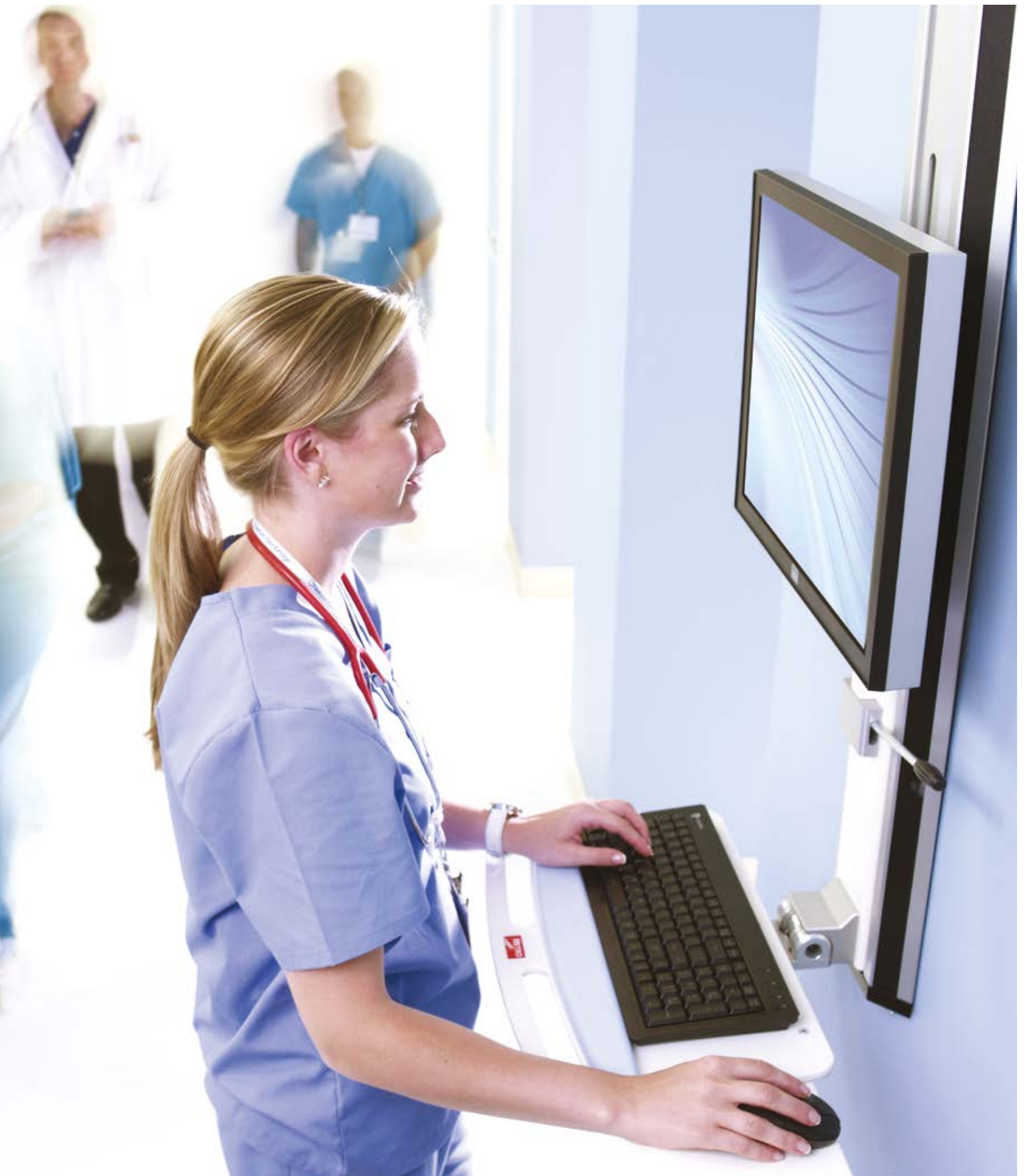

# METROMOUNT

## WALL MOUNTED COMPUTER STATIONS

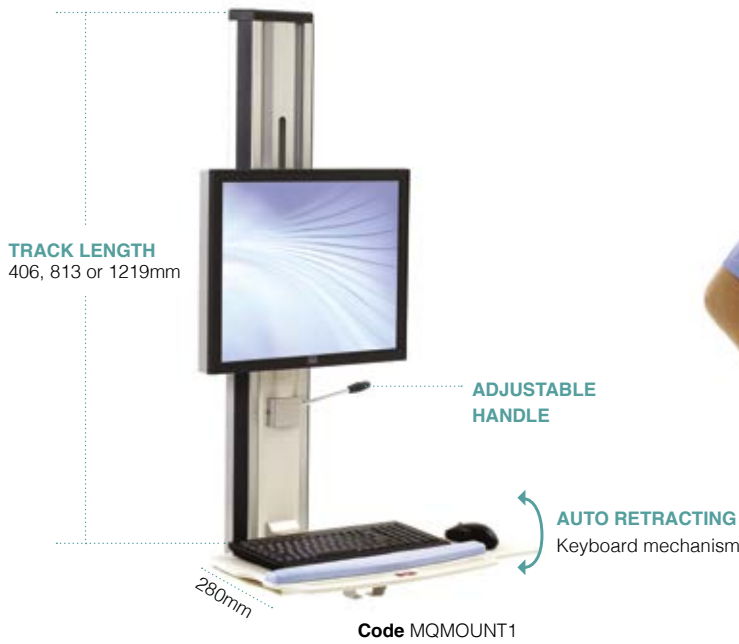

### SLIMLINE SYSTEM

Actuator handle, allows for effortless adjustments, optimising workflow efficiencies while sitting or standing.

### SIMPLE INSTALLATION

Pre-assembled resulting in minimal installation down time. Maximum load 18kg.

### VERSATILE SYSTEM

Superior overall height adjustment range compared to other workstations maximises versatility, ergonomics and comfort.

### BUILT FOR LIFE

Maximum durability leads to long term dependability. Intelligently designed around your technology requirements.

### AVAILABLE IN A VARIETY OF OPTIONS WHICH ARE ALL DESIGNED TO STORE...

MetroMount™ wall arm systems keep information and patient data available at the point-of-care. These durable wall arms and mounts install in minutes and offer access to information from a patient room or hallway.

Designed to be store compactly and out of the way to maximise space. The wall arm systems are easily adjustable with a single-handed motion to allow nurses to work comfortably.

Monitor and accessories not included.  
All walls must be fully evaluated before installation.





MJ4450-2005 shown

MJ4450-1005 shown

## MOBILE HIGH DENSITY RECHARGE STATION

SAFELY STORES & RECHARGES ELECTRICAL DEVICES



### MOBILE CHARGE STATION

Dramatically reduces the space needed to recharge electrical devices. Units supplied with two multi-position shelves. Additional shelves available.

### UK MAINS SOCKETS 230v 50 Hz

3 x double sockets on single unit.  
6 x double sockets on double unit.

### RCD SAFETY CUT OUT

Additional protection against electric shocks for instant power cut out.

### EMERGENCY STOP BUTTON

Safety mechanism that turns power supply off - completely and quickly.

### SINGLE RECHARGE TROLLEY 1040 x 462 x 1435mm

Code	Description
MJ4450-1005	Single unit with 6 sockets

### DOUBLE RECHARGE TROLLEY 2030 x 462 x 1435mm

Code	Description
MJ4450-2005	Double unit with 12 sockets

**ONE PIECE FULLY WELDED FRAME**  
**LONG SPAN SHELVES WITH HOOK SUPPORT**  
**125MM SWIVEL CASTERS, 2 WITH BRAKES, 1 X ANTISTATIC LOCKING BRAKES**  
**REMOVABLE SHELVES FOR CLEANING**  
**10 YEAR METAL WORK GUARANTEE**

**FRAME COLOUR OPTIONS:** Lilac available from stock



Lilac Pale green White Grey Red



LECCRP2 cart with accessories



LECCRP3 cart with accessories



LECCRP4 cart with accessories

## LIFELINE CARTS DESIGNED FOR EMERGENCYS



Lifeline carts have Microban Anti Microbial Protection as standard - ideal for infection control.



### SUPERIOR MANOEUVRABILITY

Lightweight polymer construction, 127mm diameter castors, an ergonomic handle and an exclusive 5th wheel steering system offers excellent manoeuvrability and assures maximum control in transit.



### ORGANISATION & IDENTIFICATION

Self-closing, full access drawers in a variety of heights, drawer divider systems, exchange trays and drawer labels are available to allow access and identification of drawer contents.



### INFECTION CONTROL

Corrosion proof polymer materials, smooth rounded corners for easy cleaning and Microban Antimicrobial Product Protection that keeps the cart cleaner between cleaning.



### SECURITY

Tamper evident security seals secure the top compartment and drawers. Optional locking side bins provide additional storage.

## PRE-CONFIGURED OPTIONS

CODE	ACCESSORIES DESCRIPTION	CART CODES		
		LECCRP2	LECCRP3	LECCRP4
LEC143	Top Cavity Tray		X	
FL211	Side Bin (1)-Locking		3	3
FL221	Waste Basket 28 Quart & Holder	X		
LEC 251	Lockable Sharps Container (mounts to handle side)	X		
LEC304	Adjustable Defibrillator Tray	X	X	X
LEC306	Suction Pump Shelf		X	
LEC308	Backboard with Front Assembly Kit		X	X
LEC309	Backboard with Back Assembly Kit	X		
	Included Oxygen Tank Holder	X	X	X
FL315	I. V. Pole with Cart Mount	X	X	X
LEC319	Storage/Gel Bin		X	
LEC320	Plastic Security Seals 100 pack	X	X	X
CODE	CART DESCRIPTION			
LEC24P	39" (991mm) Cart	X	X	
LEC27P	42" (1067mm) Cart			X
CODE	DRAWERS WITH CODE BLUE* DRAWER PULL			
LEC103	3" (76mm) Drawer	1	2	2
LEC106	6" (152mm) Drawer	3	1	1
LEC109	9" (203mm) Drawer		1	
LEC112	12" (305mm) Drawer			1

Lifeline carts are available in a choice of heights and with a variety of accessories.

Red Lifeline carts are also available:

Please contact Medstor for additional information and personalised specification





Flexline carts have Microban Anti Microbial Protection as standard - ideal for infection control.

FLEX4 cart with accessories

## FLEXLINE CARTS

DESIGNED WITH INTERCHANGEABLE COMPONENTS AND ACCESSORIES



### EASY MOBILITY

Lightweight polymer construction, integrated cart handles and 127mm polyurethane castors, 2 directional and 2 total lock, provide for smooth transport and nimble manoeuvring.



### ORGANISATION & IDENTIFICATION

Self-closing, full access drawers in a variety of heights, drawer dividers and labels, side storage accessories and an overbridge system are available to allow for easy access and identification of cart contents.



### INFECTION CONTROL

Flexline helps improve infection control with a cleaner design that includes corrosion proof polymer materials, smooth rounded corners to allow for easy cleaning and \*Microban® Antimicrobial Product Protection that keeps the cart cleaner between cleans.



### SPACIOUS WORKSURFACE

Provides a smooth writing surface or ample space for prep work. For additional work space an optional pass through side shelf is available as an added bonus.

**Flexline carts are available in a wide range of preconfigured options to suit many standard procedures or can be made to specific customer requirements**  
**Please contact Medstor for additional information and personalised specification.**





## STARSYS CARTS

A RANGE OF CARTS TO SUIT EVERY APPLICATION



### ELECTRONIC LOCKS

Authorised access without keys. Optional upgrades include audit tracking, access reports and card reader entry.



### TECHNOLOGY

A variety of power and technology options are available to provide real time access to information.



### ACCESSORIES

A wide range of accessories are available to enable you to create a cart to suit your specific needs.

## BUILD A PERSONALISED CART

Trauma, General supply, Anaesthesia, Anthroscopic, Isolation, Dressing, Critical care, Laproscopic, IV Therapy, Bedside care, ITU, General procedures and Medication dispensing.

PLEASE CONTACT MEDSTOR FOR ADDITIONAL INFORMATION AND PERSONALISED SPECIFICATION



### INFECTION CONTROL

Corrosion proof polymer materials, smooth rounded corners for easy cleaning and Microban Antimicrobial Product Protection that keeps the cart cleaner between cleaning.



Microban Anti Microbial Protection as standard - ideal for infection control.

### NEED MORE SPACE ?

Side opening additional storage units more than double the work surface.





## STARSYS MODULAR TRANSPORT AND STORAGE SYSTEMS:

With a wide range of static and mobile workcentres, carts and overhead storage solutions - Starsys offers a solution for every Healthcare environment.

### Starsys benefits:

- Corrosion proof polymer components.
- Microban antimicrobial protection.
- Limitless range of configurations.
- Durable easy to clean polymer construction.
- Unique solutions to your exact requirements.



EQUIP CART



LIGHT CART



POWER CART

## MEDSTOR “R” CARE I.T. CARTS

CUSTOM DESIGNED FOR HEALTHCARE



### EASY TO MANOEUVRE

High stability, sit or stand height cart adjustment, manufactured in light weight materials.



### HYGIENIC DESIGN

Quality materials with simple lines to reduce cleaning procedure times.



### BATTERY PACK

Embedded or removable battery system will provide extra electrical equipment operational time.



### CONFIGURED FOR YOU

Combine with a range of accessories to produce a bespoke option.

**Sit to Stand height adjustment (768mm to 1108mm)**  
**100mm wheels (2 locking) Steel and Aluminium construction**  
**Standard 2 year warranty (extend to 5 on request)**  
**Tested to IEC60601-1-2 (Edition 3)**

**PLEASE CONTACT MEDSTOR FOR ADDITIONAL INFORMATION AND PERSONALISED SPECIFICATION**

### DISTRIBUTION CARTS -

Code	W (mm)	D (mm)	H (mm)	Description
MY0400	740	x 535	x 768/1108	Equip Cart
MY0200	544	x 488	x 768/1108	Light Cart
MY0300	740	x 535	x 768/1108	Power Cart

MY0200 with multi-coloured drawers





# PRACTICAL APPLICATION

## CONTROLLING STOCK LEVELS



Smartkanban is a material management system for use at the point of consumption. It takes the dual bin system to the next level by using a combination of RFID and IT technologies.



READER DEVICES



RFID TAGS

Palex Medical RFID System

Innovative solutions to healthcare product handling, storage and logistics.



### ACCESSORIES

Code	Description
MY2000A	Keyboard drawer with mouse tray
MY2000B	Medicine drawer - optional electric lock
MY2000C	Universal basket for patient files
MY2000D	Gel holder - selection of sizes available
MY2000E	Standard DIN rail
MY2000F	Scanner holder
MY2000G	Table computer stand
MY2000H	Double VESA head display or tablet holder
MY2000I	Second work surface
MY2000J	Mouse holder



MY200A



MY200B



MY200C



MY200D



MY200E



MY200F



MY200G



MY200H



MY200I



MY200J



## SMARTKANBAN - RFID

### CONTROL SUPPLIES & MEDICATION:

Eliminates stock outs and time expiries, saving costs

- Reduction of up to 30% in stock levels
- Provides a rapid return on investment
- Reduces workload associated with stock takes
- Prompts and alerts for fail-safe stock levels
- Unified stock management - Pharmacy and CSSD
- Access product consumption at anytime
- RFID Technology HF. Connectivity via Ethernet

**PLEASE CONTACT MEDSTOR FOR ADDITIONAL INFORMATION AND PERSONALISED SPECIFICATION**



#### EASY TO USE

Optimise restocking based on RFID technology based on a white and orange card stock system.



#### CONTROL SUPPLIES & MEDICATION

Eliminate stock outs and time expiries saving costs.



#### STOCK AREAS OR WARD USE

The wall mounted 600 stock tag or 200 tag Mailbox design.



#### I.T. SYSTEMS

Full automatic integration with central warehouse ordering systems.

# AVOID CLERICAL ERRORS

HERE'S HOW IT WORKS... FOR DUAL BIN OPERATIONS

## FIRST COMPARTMENT OUT OF STOCK

Place the white card in the wall mounted PK600 or post into the BK200.

## TOTAL STOCK OUT/URGENT REQUIREMENT

Take the orange card and do the same.

## PK200 READER...

- Automatically generates a restock order to the central warehouse
- Item is replaced and the card returned ready for use again

Secure wall mounted unit with 200 tag capacity.

## PK600 READER...

- Automatically generates a restock order to the central warehouse
- Item is replaced and the card returned ready for use again

Wall mounted, easily accessible in high volume stock areas - 600 tags.



PK200 reader



PK600 Wall reader

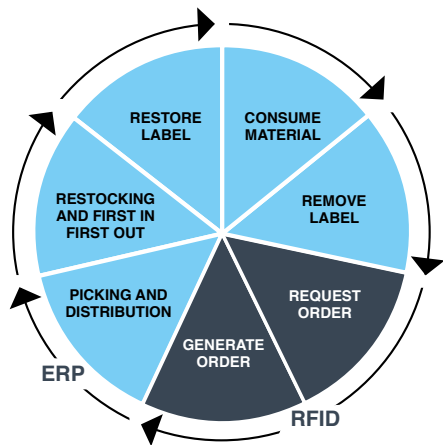

Smartkanban is a material management system for use at the point of consumption. It takes the dual bin system to the next level by using a combination of RFID and IT technologies.



READER DEVICES



RFID TAGS

Palex Medical RFID System



CLIENTS SIDE

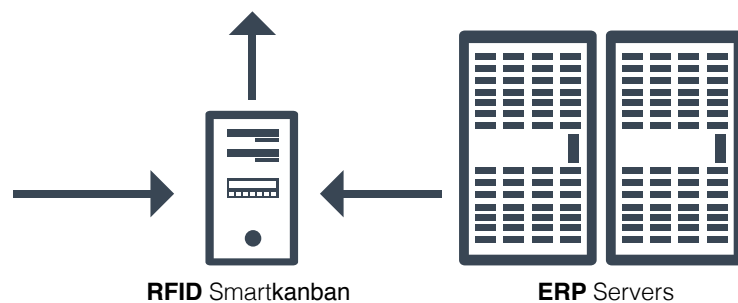



The best locking security, flexible access right management, to save time, money and the environment.

## ILOQS10 - DIGITAL LOCKING

### ELECTRONIC KEY LOCKING SYSTEM



#### COMPLETE LOCKING SYSTEM

iLOQ S10 locking system offers a modern Internet based solution for secure and advanced administration of locks and keys.



#### AWARD-WINNING SOLUTION

The iLOQ locking solution has won several awards in the security industry.

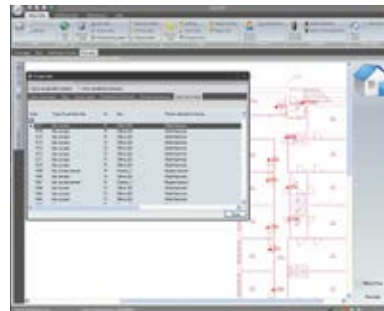

#### DEVELOPED FOR HIGH SECURITY

Easy-to-use software provides access rights and locking management tools for each key and lock.



iLOQ Self-powered Digital Lock Cylinder



iLOQ C10S.50 Furniture lock

#### NO BATTERIES

Electronically keyed iLOQ S10 locking system is uniquely self-powered by harvesting electricity from the insertion of the key.

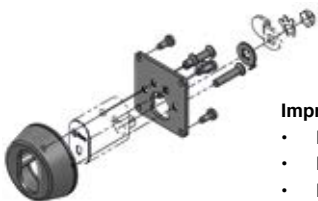

#### Improve locking security

- Patented self-powered electromechanical lock cylinder
- Battery free key with encrypted digital identification
- Powerful encryption and security features
- Easy and fast elimination of lost keys



#### Remove keying restrictions

- Fully programmable locks and keys
- Proven communication and software
- Easy to use user interface



#### Save time, money and the environment

- Easy and fast installation and maintenance
- No cables or batteries needed
- Cost efficient operative function
- Minimises lost key costs



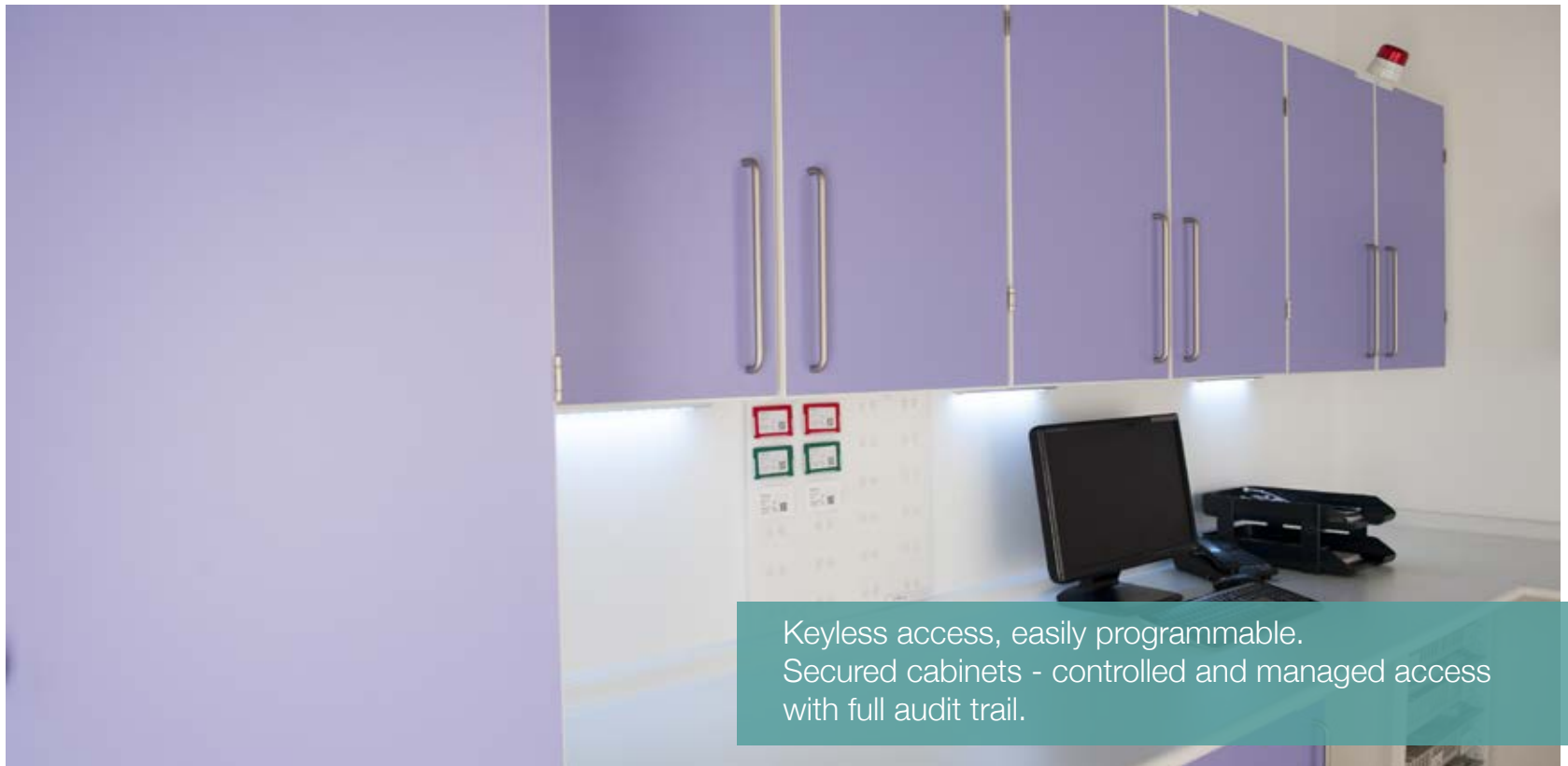

Keyless access, easily programmable.  
Secured cabinets - controlled and managed access with full audit trail.

## PROXIMITY LOCKING

TRANSPONDER TECHNOLOGY FOR CABINETS AND CARTS



### COMPLETE LOCKING SYSTEM

Electronic circuit is activated by pressing the button with an electronic key  
Stores last 150 transactions.

LED shows programming and lock status  
Integrated real-time clock to programme time-limited locking authorisations  
Serial interface for the communication with portable programming devices.



### INFORMATION TERMINAL SET

Indicates which proximity lock number key is authorised. Neutralises keys Macro capable; a macro provides customised extension of functions.

- With 4-line LC display (16 characters each), 2 function keys
- Integrated infrared interface
- Supply voltage: 8-9 V AC or 10-12 V DC
- Continuous current consumption: 200mA
- Temperature of operating area: 0-60°C (non condensing)
- IP 65 rated



### DIALOCK KEY WITH WRISTBAND

- 41 x 34 x 4.5 mm (excluding wristband)
- User key - 1 locking authorisation per key
- Polyamide, black with white insert



### S4 KEY TAG

- Dimensions: (H x W x D) 43 x 34 x 5 mm
- For attaching to key ring
- User key - 4 locking authorisations per key tag.



**PLEASE CONTACT MEDSTOR FOR ADDITIONAL INFORMATION OR TO SCHEDULE AN INFORMAL MEETING.**

# LAUNDRY & CONTRACT COLLECTION

BAG HOLDERS - MOBILE LINEN TROLLEYS

## HYGIENIC PRACTICES

Ensuring safe and secure laundry transportation.

- I.V. poles
- Contract ward furniture
- Cylinder holders







## LINEN DISTRIBUTION

### ALUMINIUM TRUCKS



**Code H1560** - shown with single shelf



**Code H15502**



**Code H1600**

AVAILABLE WITH UPPER AND LOWER BUMPERS  
 STRONG NON-TWISTING STEEL FRAME  
 HINGED DOORS OPENING TO 270°

Optional safety door seal - automatically cuts once the door is opened.

#### LINEN DISTRIBUTION TRUCKS -

Code	W (mm)	D (mm)	H (mm)	Description
H1560	1230	x 630	x 1200	1 aluminium shelf
H15502	1230	x 630	x 1500	2 aluminium shelf
H1550	1230	x 630	x 1200	2 internal steel shelf
H1600	1400	x 710	x 1740	2 internal steel shelf



#### ORGANISATION

Built to house internal full span shelves.



#### LIGHT WEIGHT

Easy to manoeuvre with ergonomic push handles - double handle grips.





Code R05102

## LAUNDRY COLLECTION

### FLAME RETARDANT BODY AND COVER

#### WATERPROOF TRUCK

Code	W (mm)	D (mm)	H (mm)	Description
R05102	1220	x 562	x 1800	With 2 wire shelves and cover
R05103	1220	x 562	x 1800	With 3 wire shelves and cover

- Polyethylene waterproof construction
- Flame retardant cover
- Sloping top design
- Selection of unit colour options

**PLEASE CONTACT MEDSTOR FOR ADDITIONAL INFORMATION AND PERSONALISED SPECIFICATION**



#### MOBILITY

2 fixed and 2 swivel 125mm castors.



#### PROTECTIVE COVER

Waterproof fabric and flame retardant drop down cover.



#### FIXED SHELVES

Wire shelves are coated for waterproof protection.

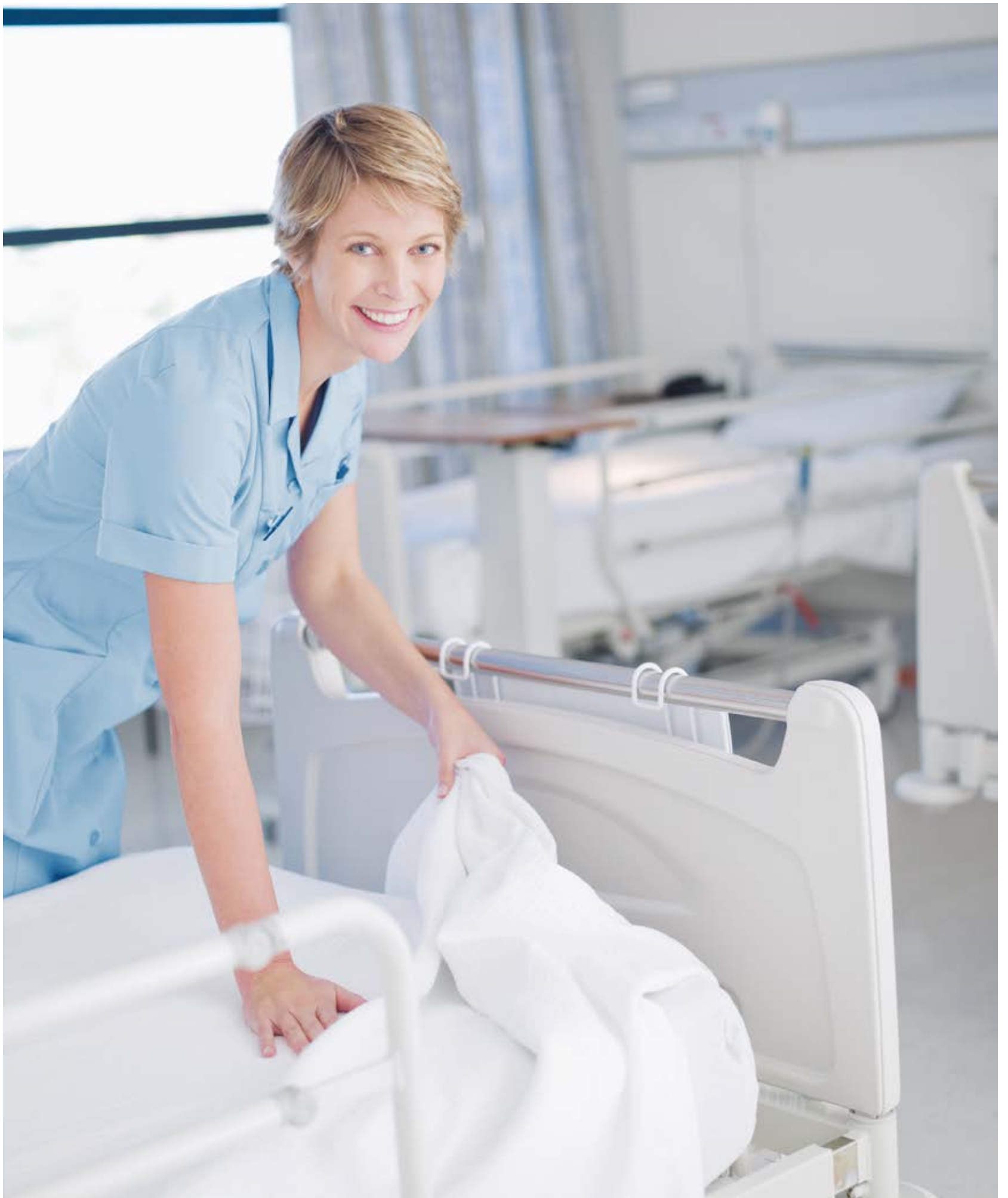

# LAUNDRY COLLECTION

## BAGS - BAG HOLDERS

LAUNDRY BAGS 100% POLYESTER  
NO CONTACT TRANSPORTATION SYSTEM  
BOILING AND TUMBLE-DRY QUALITIES

Medstor offer a 1000 wash guarantee on all bags.



### LAUNDRY BAGS - 100% POLYESTER

Code	W (mm)	D (mm)	H (mm)	COLOUR
S3210BL	460	x 430	x 870	Black
S3210B	460	x 430	x 870	Blue
S3210W	460	x 430	x 870	White
S3210R	460	x 430	x 870	Red
S3210G	460	x 430	x 870	Green
S3210GR	460	x 430	x 870	Grey

Additional bag sizes available on request

LINEN BAG COLOUR OPTIONS: Available from stock



Laundry bag is tied securely to the open frame bag holder.

SPRUNG FRAME LINEN BAG HOLDERS  
USE WITH FABRIC OR POLYTHENE BAGS  
EASY CLEAN PANELS  
NON MARKING CASTORS

Suitable for fabric or polythene bags 1500mm circumference.  
Adjustable to suit other bag sizes (Minimum bag height 750mm).

### SINGLE LINEN BAG HOLDER

Code	W (mm)	D (mm)	H (mm)	Description
MS3206	335	x 160	x 305	Single bag holder

FRAME COLOUR OPTIONS: Lilac available from stock



Open frame linen bag



MS3206 shown with linen bag

# LAUNDRY COLLECTION

COLOUR COATED MILD STEEL AND STAINLESS STEEL OPTIONS



**FRAME COLOUR OPTIONS:** Lilac available from stock



**COATED STEEL LINEN BAG TROLLEY**  
**FOR USE WITH 1500 CIRCUMFERENCE BAGS**  
**EASY CLEAN PANELS**  
**COLOURED MILD STEEL**

Suitable for fabric or polythene bags 1500mm circumference.  
 Adjustable to suit other bag sizes. Minimum bag height 750mm

### MILD STEEL LINEN BAG HOLDERS

Code	W (mm)	D (mm)	H (mm)	Description
MS3201PC	550	380	1060	Single bag holder
MS3202PC	800	420	910	Double bag holder



MS3201PC shown



MS3202PC shown with linen bag

**STAINLESS STEEL BAG TROLLEY**  
**FOR USE WITH 1500 CIRCUMFERENCE BAGS**  
**FITTED WITH 125mm CASTORS**

We supply a full range of linen bags in a selection of colours.  
 Blue / Green / White / Grey / Red

### STAINLESS STEEL LINEN BAG HOLDERS

Code	W (mm)	D (mm)	H (mm)	Description
MS3201SS	550	380	1060	Single bag holder
MS3202SS	800	420	910	Double bag holder



MS3201SS shown



MS3202SS shown

**PEDAL OPERATED ALUMINIUM FORMED LID**  
**2 FIXED AND 2 SWIVEL CASTORS**  
**SELECTION OF LID COLOURS**

We supply a full range of linen bags in a selection of colours.  
 Blue / Green / White / Grey / Red



Pedal operated



Simple cord attachment



MS3200 shown with and without bag

### LINEN BAG HOLDER WITH LID

Code	W (mm)	D (mm)	H (mm)	Description
MS3200	460	430	870	Single bag holder with pedal

# LAUNDRY COLLECTION

## COMBINATION TROLLEY AND MOBILE LINEN TROLLEY

**FRAME COLOUR OPTIONS:** Lilac available from stock



**CENTRAL PANEL FOR SEGREGATION**  
**REMOVABLE ALUMINIUM TRAYS**  
**10 YEAR GUARANTEE**

We supply a full range of linen bags in a selection of colours.  
 Blue / Green / White / Grey / Red

### COMBINATION LINEN TROLLEYS

Code	W (mm)	D (mm)	H (mm)	Description
MS3208	815	x 483	x 1130	Bag holder with 3 trays

Lilac trolleys are available via fast track delivery



MS3208 trolley shown with linen bag

**FOUR SECURE CORNER FIXINGS**  
**ONE PIECE WELDED FRAME FOR STRENGTH**  
**100mm NON MARKING CASTORS**

Max working load recommended 4 corner fixing - 200kg load

### HAMPER STYLE LINEN TROLLEY

Code	W (mm)	D (mm)	H (mm)	Description
MS3205	820	x 910	x 995	Linen trolley



Extensively used by NHS hospitals



MS3205 trolley shown with linen bag

**STEEL FRAMEWORK WITH ALUMINIUM PANELS**  
**2 ADJUSTABLE SHELVES**  
**4 BUFFERED CASTORS WITH 2 FRONT LOCKING**

MS3207-FC Pull down protective fabric front cover for linen trolley Non velcro fastening

### MOBILE LINEN TROLLEY

Code	W (mm)	D (mm)	H (mm)	Description
MS3207	1170	x 510	x 1030	Storage trolley
MS3207-FC	1150	x 4	1000	Protective cover



Protective fabric cover



MS3207 shown



# TRANSPORTATION & STORAGE

## CYLINDER TROLLEYS - HOLDERS - WALL BRACKETS

FRAME COLOUR OPTIONS: Lilac available from stock



**HOLDS CYLINDERS SECURELY IN PLACE**  
**CAPTIVE CHAIN DESIGN**  
**ANTI STATIC WHEELS**

We supply holders to suit all cylinder sizes.  
 Please contact sales for additional information.

### CYLINDER TROLLEYS

Code	W (mm)	D (mm)	H (mm)	Description
MS3502	305	x 265	x 820	A/F sized holder
MS3503	560	x 420	x 1150	F or G type holder

Lilac cylinder trolleys are available via fast track delivery



MS3502 shown



MS3503 shown

**BALANCED CARRY HANDLE**  
**FITS TO MOST BED SIDES AND MEDI-RAILS**  
**WALL BRACKET FOR PORTABLE CYLINDER HOLDER**

Lilac oxygen carriers are available from stock via our fast track delivery program.

### PORTABLE OXYGEN CARRIER

Code	W (mm)	D (mm)	H (mm)	Description
MS3504	390	x 150	x 385	D & E sized cylinders
MS3501	880	x 420	x 910	Fits D cylinders
MS501-WB	Wall bracket for MS3501			



MS3504 shown



MS3501 shown with wall bracket

**ONE PIECE DESIGN**  
**CAPTIVE CHAIN TO SECURE CYLINDERS**  
**WALL FIXING PRE-DRILLED HOLES**  
**MILD STEEL**

Lilac oxygen carriers are available from stock via our fast track delivery program.

### DOUBLE CYLINDER WALL BRACKET HOLDER

Code	W (mm)	D (mm)	H (mm)	Description
MS3500-1	359	x 107	x 88	D & E sized cylinders
MS3500-2	435	x 126	x 88	F sized cylinders
MS3500-3	511	x 145	x 88	G sized cylinders
MS3500-4	613	x 170	x 88	J sized cylinders



MS3500-01 shown



Wall bracket - Fits variety of sizes

# I.V. & DRIP STANDS

CE MARKED - CLASS 1 DEVICE - CONFORMS TO BS3619:1976



**FIVE LEGS TO ASSIST STABILITY**  
**30MM DIAMETER SCRATCH RESISTANT STAINLESS STEEL UPRIGHT**  
**50MM TWIN WHEEL CASTORS SHIELDED FROM FLUID SPILLS**  
**TWO OR FOUR SEAMLESSLY WELDED PIGTAIL HOOKS**  
**MAXIMUM HOOK LOAD 4KG (PER STAND)**  
**SUITABLE FOR USE WITH TWO INFUSION PUMPS/SYRINGE DRIVERS**  
**(MAX 4KG PER STAND).**

## ANGLE TILT TESTED

REF	Description
A	Test 1 stability test to BS 3619:1976 with single infusion 1000ml dispenser 9° permissible angle achieved.
B	Test 2 with Flo-gard pump at 0.8m height and infusion dispenser at 1.9m 11° permissible angle achieved.
C	Test 3 with Flo-gard pump at 1.0m height and infusion dispenser at 1.9m 9° permissible angle achieved.

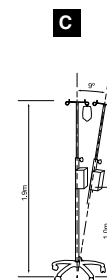
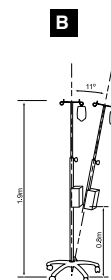
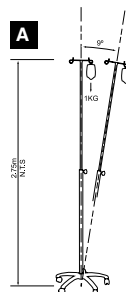

## TWO HOOK I.V. POLE/DRIP STAND 200 - 1200mm

Code	Description
MS3302	Two hook stand
MS3302-WB	Two hook stand with weighted base pole

## FOUR HOOK I.V. POLE/DRIP STAND 200 - 1200mm

Code	Description
MS3304	Four hook stand
MS3304-WB	Four hook stand with weighted base pole



MS3302 shown



MS3304 shown



Two hook design



Four hook design



Weighted base pole

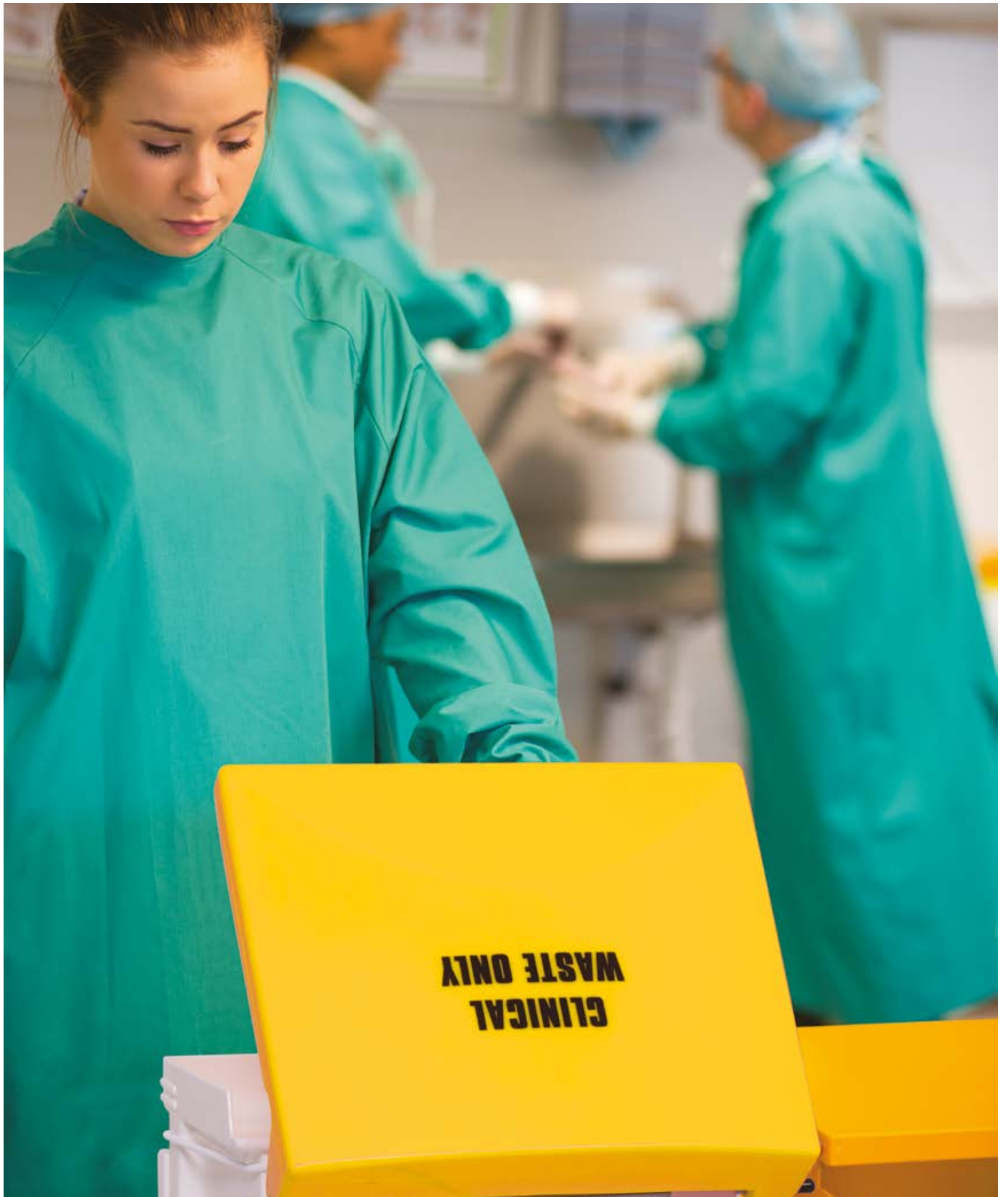



# REFUSE AND RECYCLING

## SOFT CLOSING LID PEDAL OPERATED

MANUFACTURED FROM HIGH DENSITY POLYETHYLENE  
 TESTED TO NHS TECHNICAL MEMORANDUM 83 (FIRE SAFETY)  
 ALL UNITS FITTED WITH BAG CORD  
 STAINLESS STEEL PUSH ROD

Moulded-in personalised graphics available for additional cost.



Pedal operated



Silent closing lid option

**LID COLOURS:** Please suffix code:

Suffix B	Suffix O	Suffix Y
Black	Orange	Yellow



MT0036200 shown

MT003765B shown

### FIRE RETARDANT SACK HOLDER

Code	W (mm)	D (mm)	H (mm)	Description
MT0036200	620	240	405	Fixed sack holder
MT003765B	810	400	480	Mobile sack holder

Lid does not touch the wall when opening.



# WASTE HOLDERS

## SOFT CLOSING LID PEDAL OPERATED

SILENT & SOFT CLOSING HINGES  
 SWIVEL AND BRAKE CASTOR DESIGN  
 SOFT CLOSING LID - HANDLE OPERATED  
 STAINLESS STEEL TUBULAR FRAME

### Lid available in:

White, blue, brown, yellow, red or green.

### BAG HOLDER TROLLEY

Code	W (mm)	D (mm)	H (mm)	Description
T0165	360	510	910	Single bag holder
T0265	735	510	910	Double bag holder



T0165 shown



T0265 shown

### PEDAL OPERATED:

Unfold back edge grip and place new bag into recess -  
 Fold back over ready for use.

HEAVY DUTY STAINLESS STEEL FRAME  
 SILENT & SOFT CLOSING HINGES  
 SWIVEL AND BRAKE CASTOR DESIGN  
 SOFT CLOSING LID - HANDLE OPERATE

### Lid available in:

White, blue, brown, yellow, red or green.

### HEAVY DUTY BAG HOLDER TROLLEY

Code	W (mm)	D (mm)	H (mm)	Description
T0166	400	500	910	Single bag holder
T0266	750	500	910	Double bag holder



T0166 shown



T0266 shown



# WASTE HOLDERS

## HINGED CLOSING REFUSE HOLDERS

- SILENT & SOFT CLOSING HINGES
- SWIVEL AND BRAKE CASTOR DESIGN
- ABS RECESSED BASE PLATFORM
- STAINLESS STEEL TUBULAR FRAME

Clamp shut lever ensures unpleasant odours are sealed inside the bag minimising emissions in wards and public areas.

### 4 WHEEL BAG HOLDER TROLLEY

Code	W (mm)	D (mm)	H (mm)	Description
T1970	600	470	990	70 Litre holder
T1940	600	470	830	40 Litre holder



T1970 shown



T1940 shown

### BAG REPLACEMENT:

Maximum hygiene with no contact to soiled refuse bag. Foot pedal operated bag replacement mechanism.



T0970 shown



T0940 shown

- SILENT & SOFT CLOSING HINGES
- STATIC FRONT FEET - SWIVEL BACK CASTORS
- ABS RECESSED BASE PLATFORM
- STAINLESS STEEL TUBULAR FRAME

Clamp shut lever ensures unpleasant odours are sealed inside the bag minimising emissions in wards and public areas.

### 2 WHEEL BAG HOLDER TROLLEY WITH FEET

Code	W(mm)	D(mm)	H(mm)	Description
T0970	600	470	990	70 Litre holder
T0940	600	470	830	40 Litre holder



# INDEX

## PRODUCT CODES & PAGE NUMBERS

PLEASE CONTACT MEDSTOR FOR ADDITIONAL INFORMATION OR TO SCHEDULE AN INFORMAL MEETING.

Information and specification are subject to change without notice.  
Please confirm at point of order. E&OE.

Cat No	Page No	Cat No	Page No	Cat No	Page No	Cat No	Page No	Cat No	Page No
A0645	92	B0507RH	73	B1008	70	D3085LD	79	H4619RHM	54
A0648	92	B0507SD	73	B100810D	70	D3085R	79	H4619SDM	54
A0665	92	B0508	69	B10088D	70	D3085RD	79	H4619SDMD	55
A0668	92	B05084D	69	B1008LDD	70	D3585L	79	H5709RSM	54
A0945	92	B05085D	69	B1008OLH	70	D3585LD	79	H5709RSM	55
A0948	92	B0508LDD	69	B1008ORH	70	D3585R	79	H5713RSM	54
A0965	92	B0508LH	69	B1008RDD	70	D3585RD	79	H5713RSM	55
A0968	92	B0508RDD	69	B1008SD	70	DC1685	79	H5718RSM	54
A1345	92	B0508RH	69	B1008SDD	70	DC2285	79	H5718RSM	55
A1348	92	B0508SD	69	B1009	74	DC2685	79	H5719RSM	54
A1365	92	B0508SDD	69	B1009LH	74	DR1285	79	H5719RSM	55
A1368	92	B0509	73	B1009RH	74	DR1585	79	H6409LHM	54
A1745	92	B0509LH	73	B1009SD	74	DR2385	79	H6409LHMD	55
A1748	92	B0509RH	73	B1200	56			H6409M	54
A1765	92	B0509SD	73	B1205	74	EF0401	82	H6409MD	55
A1768	92	B0605	73	B1205LH	74	EF0401	85	H6409RHM	54
		B0605LH	73	B1205RH	74	EF0601	82	H6409SDM	54
B0305	73	B0605RH	73	B1205SD	74	EF0601	85	H6409SDMD	55
B0305LH	73	B0605SD	73	B1206	74	ELS0401	82	H6413LHM	54
B0305RH	73	B0606	73	B1206LH	74			H6413LHMD	55
B0305SD	73	B0606LH	73	B1206RH	74	F0100	25	H6413M	54
B0306	73	B0606RH	73	B1206SD	74	F0101	25	H6413MD	55
B0306LH	73	B0606SD	73	B1207	74	F0102	25	H6413RHM	54
B0306RH	73	B0607	73	B1207LH	74	F0102	25	H6413SDM	54
B0306SD	73	B0607LH	73	B1207RH	74	F0103	25	H6413SDMD	55
B0307	73	B0607RH	73	B1207SD	74	F0107	25	H6418LHM	54
B0307LH	73	B0607SD	73	B1208	70	F0111	25	H6418LHMD	55
B0307RH	73	B0608	69	B120810D	70	F0160	25	H6418M	54
B0307SD	73	B06084D	69	B12088D	70	F0170	25	H6418MD	55
B0308	69	B06085D	69	B1208LDD	70	F0180	25	H6418RHM	54
B03084D	69	B0608LDD	69	B1208OLH	70	F0201	25	H6418SDM	54
B03085D	69	B0608LH	69	B1208ORH	70	F0202	25	H6418SDMD	55
B0308LDD	69	B0608RDD	69	B1208RDD	70	F0301	25	H6419LHM	54
B0308LH	69	B0608RH	69	B1208SD	70	F0301	25	H6419LHMD	55
B0308RDD	69	B0608SD	69	B1208SDD	70	FL211	140	H6419M	54
B0308RH	69	B0608SDD	69	B1209	74	FL221	140	H6419MD	55
B0308SD	69	B0609	73	B1209LH	74	FL315	140	H6419RHM	54
B0308SDD	69	B0609LH	73	B1209RH	74			H6419SDM	54
B0309	73	B0609RH	73	B1209SD	74	H1550	152	H6419SDMD	55
B0309LH	73	B0609SD	73	B1500	56	H15502	152	H7509RSM	54
B0309RH	73	B0805	74	B1600	56	H1560	152	H7509RSM	55
B0309SD	73	B0805LH	74	B2136	57	H1600	152	H7513RSM	54
B0405	73	B0805RH	74	B2139	57	H1622	104	H7513RSM	55
B0405LH	73	B0805SD	74	B2141	57	H1625	104	H7518RSM	54
B0405RH	73	B0806	74	B2400	56	H3150	105	H7518RSM	55
B0405SD	73	B0806LH	74	B2400	57	H3162	104	H7519RSM	54
B0406	73	B0806RH	74	B2500	57	H3165	104	H7519RSM	55
B0406LH	73	B0806SD	74	B2600	57	H3170	105	HD0401	85
B0406RH	73	B0807	74	B2639	57	H3180	105	HD0601	85
B0406SD	73	B0807LH	74	B2900	57	H35160000	134		
B0407	73	B0807RH	74	B3001	57	H35500600	134	LEC103	140
B0407LH	73	B0807SD	74	B3002	57	H35509600	134	LEC106	140
B0407RH	73	B0808	70	B6001	57	H4609LHM	54	LEC109	140
B0407SD	73	B080810D	70	B6002	57	H4609LHMD	55	LEC112	140
B0408	69	B08088D	70	B6605	77	H4609M	54	LEC143	140
B04084D	69	B0808LDD	70	B6605LH	77	H4609MD	55	LEC24P	140
B04085D	69	B0808OLH	70	B6605RH	77	H4609RHM	54	LEC251	140
B0408LDD	69	B0808ORH	70	B6606	77	H4609SDM	54	LEC27P	140
B0408LH	69	B0808RDD	70	B6606LH	77	H4609SDMD	55	LEC304	140
B0408RDD	69	B0808SD	70	B6606RH	77	H4613LHM	54	LEC306	140
B0408RH	69	B0808SDD	70	B6607	77	H4613LHMD	55	LEC308	140
B0408SD	69	B0809	74	B6607LH	77	H4613M	54	LEC309	140
B0408SDD	69	B0809LH	74	B6607RH	77	H4613MD	55	LEC319	140
B0409	73	B0809RH	74	B6609	77	H4613RHM	54	LEC320	140
B0409LH	73	B0809SD	74	B6609LH	77	H4613SDM	54	LECCRP2	140
B0409RH	73	B1005	74	B6609RH	77	H4613SDMD	55	LECCRP3	140
B0409SD	73	B1005LH	74	B8808	77	H4618LHM	54	LECCRP4	140
B0505	73	B1005RH	74	B8808LH	77	H4618LHMD	55	Locking1	125
B0505LH	73	B1005SD	74	B8808RH	77	H4618M	54	Locking2	125
B0505RH	73	B1006	74			H4618MD	55	Locking3	125
B0505SD	73	B1006LH	74	D1285	79	H4618RHM	54	LS0601	82
B0506	73	B1006RH	74	D1585	79	H4618SDM	54		
B0506LH	73	B1006SD	74	D1685	79	H4618SDMD	55	M0301	21
B0506RH	73	B1007	74	D2285	79	H4619LHM	54	M0301AS	23
B0506SD	73	B1007LH	74	D2385	79	H4619LHMD	55	M0302	21
B0507	73	B1007RH	74	D2685	79	H4619M	54	M0302AS	23
B0507LH	73	B1007SD	74	D3085L	79	H4619MD	55		

# INDEX

## PRODUCT CODES & PAGE NUMBERS

PLEASE CONTACT MEDSTOR FOR ADDITIONAL INFORMATION OR TO SCHEDULE AN INFORMAL MEETING.

Information and specification are subject to change without notice.  
Please confirm at point of order. E&OE.

Cat No	Page No	Cat No	Page No	Cat No	Page No	Cat No	Page No	Cat No	Page No
M0305	21	M3465SDP	42	M4612RH	35	M6486DSD	39	MH1203-0080	128
M0305AS	23	M3470	41	M4612RHP	35	M6486LH	36	MH1203-0460	128
M0311	21	M3470DD	45	M4612SD	35	M6486RH	36	MH1206-0000	128
M0311AS	23	M3470LDD	45	M4612SDP	35	M6486SD	36	MH1206-0024	128
M0312	21	M3470LH	41	M4617	32	M6487	36	MH1206-0062	128
M0601	21	M3470LHP	42	M4617LH	32	M6487	36	MH1206-0080	128
M0601AS	23	M3470RDD	45	M4617PD	32	M6487D3	39	MH1206-0460	128
M0602	21	M3470RHP	42	M4617SD	32	M6487D5	39	MH2103-0000	132
M0602AS	23	M3470RS	42	M4621	32	M6487DRH	39	MH2103-0003	132
M0605	21	M3470SD	41	M46211000	63	M6487DSD	39	MH2103-0031	132
M0605AS	23	M3470SDD	45	M46211101	63	M6487RH	36	MH2103-0050	132
M0611	21	M3470SDP	42	M4621LH	32	M6487SD	36	MH2103-0112	132
M0612	21	M3475	41	M4621PD	32	M6660	29	MH2103-0320	132
M0631	21	M3475DD	45	M4621RH	32	M6662	29	MH2106-0000	132
M0631AS	23	M3475LDD	45	M4621SD	32	M6663	29	MH2106-0003	132
M0632	21	M3475LH	41	M4686	36	M6664	29	MH2106-0031	132
M0632AS	23	M3475LHP	42	M4686D3	39	M6667	28	MH2106-0050	132
M0635	21	M3475RDD	45	M4686D5	39	M6669	26	MH2106-0112	132
M0635AS	23	M3475RH	41	M4686DLH	39	M6670	28	MH2106-0320	132
M0641	21	M3475RH	41	M4686DRH	39	M6671	28	MH2203-0000	132
M0641AS	23	M3475RHP	42	M4686DSD	39	M6672	28	MH2203-0006	132
M0641AS	23	M3475RS	42	M4686LH	36	M6677	24	MH2203-0010	132
M0642	21	M3475SD	41	M4686RH	36	M6688	24	MH2203-0062	132
M0642AS	23	M3475SDD	45	M4686SD	36	M7011	26	MH2203-0224	132
M0642AS	23	M3475SDP	42	M4687	36	M7012	26	MH2203-0640	132
M0645	21	M3665	41	M4687D3	39	M7013	26	MH2206-0000	132
M0645AS	23	M3665DD	45	M4687D5	39	M7014	26	MH2206-0006	132
M0645AS	23	M3665LDD	45	M4687DLH	39	M7015	26	MH2206-0010	132
M0651	21	M3665LH	41	M4687DRH	39	M7016	26	MH2206-0062	132
M0651AS	23	M3665LHP	42	M4687DSD	39	M7017	26	MH2206-0224	132
M0661	21	M3665RDD	45	M4687LH	36	M7509RS	36	MH2206-0640	132
M0661AS	23	M3665RH	41	M4687RH	36	M7512RS	35	MH3103-0000	131
M0662	21	M3665RHP	42	M4687SD	36	M7517RS	32	MH3103-0003	131
M0662AS	23	M3665RS	42	M5709RS	36	M7521RS	32	MH3103-0031	131
M0665	21	M3665SD	41	M5712RS	35	M7586RS	36	MH3103-0050	131
M0665AS	23	M3665SDD	45	M5717RS	32	M7587RS	36	MH3103-0112	131
M0673-1	85	M3665SDP	42	M5721RS	32	MB4402	64	MH3106-0000	131
M0674-1	85	M3670	41	M5786RS	36	MB4403	64	MH3106-0003	131
M0690-1	82	M3670DD	45	M5787RS	36	MC2500-15	65	MH3106-0031	131
M0690-9	82	M3670LDD	45	M6400	58	MC2500-20	65	MH3106-0050	131
M0692-1	82	M3670LH	41	M6401	58	MC2500-30	65	MH3106-0112	131
M0692-9	82	M3670LHP	42	M6401S	58	MC2500-60	65	MH3106-0320	131
M1301	19	M3670RDD	45	M6402	58	MC6500-013	121	MH3203-0000	131
M1302	19	M3670RH	41	M6402P	58	MC6500-032	121	MH3203-0006	131
M1305	19	M3670RHP	42	M6409	36	MC6500-060	121	MH3203-0010	131
M1311	19	M3670RS	42	M6409D3	39	MC6500-122	121	MH3203-0062	131
M1312	19	M3670SD	41	M6409D5	39	MC6500-231	121	MH3203-0224	131
M1601	19	M3670SDD	45	M6409DLH	39	MC7500	123	MH3203-0640	131
M1602	19	M3670SDP	42	M6409DRH	39	MC7500-0003	123	MH3206-0000	131
M1605	19	M3675	41	M6409DSD	39	MC7500-0031	123	MH3206-0006	131
M1611	19	M3675DD	45	M6409LH	36	MC7500-0050	123	MH3206-0010	131
M1612	19	M3675LDD	45	M6409RH	36	MC7504	123	MH3206-0062	131
M1631	19	M3675LH	41	M6409SD	36	MC7504-0032	123	MH3206-0224	131
M1632	19	M3675LHP	42	M6412	35	MC7504-0113	123	MH3206-0640	131
M1635	19	M3675RDD	45	M6412LH	35	MC7504-0160	123	MH4106-0000	133
M1641	19	M3675RH	41	M6412LHP	35	MC7507	123	MH4106-0005	133
M1642	19	M3675RHP	42	M6412RH	35	MC75070024	123	MH4106-0014	133
M1645	19	M3675RS	42	M6412RHP	35	MC7507-0133	123	MH4106-0033	133
M1651	19	M3675SD	41	M6412SD	35	MC7507-0180	123	MH4106-0052	133
M1661	19	M3675SDD	45	M6412SDP	35	MEF0401	82	MH4106-0080	133
M1662	19	M3675SDP	42	M6417	32	MEF0401	85	MH4106-0142	133
M1665	19	M4600	58	M6417LH	32	MEF0601	82	MH4206-0000	133
M3004	58	M4600T	58	M6417PD	32	MEF0601	85	MH4206-0001	133
M3006	58	M4601	58	M6417RH	32	MF0101	100	MH4206-0014	133
M3008	58	M4602	58	M6417RH	32	MH1103-0000	128	MH4206-0028	133
M3009	58	M4609	36	M6417SD	32	MH1103-0012	128	MH4206-0066	133
M3465	41	M4609D3	39	M6421	32	MH1103-0031	128	MH4206-0284	133
M3465DD	45	M4609D5	39	M6421LH	32	MH1103-0040	128	MH4206-0916	133
M3465LDD	45	M4609DLH	39	M6421PD	32	MH1103-0230	128	MH6401	85
M3465LH	41	M4609DRH	39	M6421RH	32	MH1106-0000	128	MHD0401	85
M3465LHP	42	M4609DSD	39	M6421SD	32	MH1106-0012	128	MJ4450-1005	139
M3465RDD	45	M4609LH	36	M6421SDP	32	MH1106-0031	128	MJ4450-2005	139
M3465RH	41	M4609RH	36	M6478DLH	39	MH1106-0040	128	MLS0401	82
M3465RHP	42	M4609SD	36	M6486	36	MH1106-0230	128	MLS0601	82
M3465RS	42	M4612	35	M6486D3	39	MH1203-0000	128	MM0697-4	100
M3465SD	41	M4612LH	35	M6486D5	39	MH1203-0024	128	MM0697-6	100
M3465SDD	45	M4612LHP	35	M6486DLH	39	MH1203-0062	128	MM4479A	124
				M6486DRH	39				

# INDEX

## PRODUCT CODES & PAGE NUMBERS

PLEASE CONTACT MEDSTOR FOR ADDITIONAL INFORMATION OR TO SCHEDULE AN INFORMAL MEETING.

Information and specification are subject to change without notice.  
Please confirm at point of order. E&OE.

Cat No	Page No	Cat No	Page No	Cat No	Page No	Cat No	Page No	Cat No	Page No
MM4479B	124	MS3304	159	MY2000 H	145	Q77002012	88	S448024	112
MM4479C	124	MS3304-WB	159	MY2000 I	145	Q77002013	88	S448025	112
MM4479CPL	128, 131, 132	MS3500-1	158	MY2000 J	145	Q77002014	88	S4870	107
MM4479CSS	128, 131, 132	MS3500-2	158			Q77002015	88	S5414	112
MM4479D	124	MS3500-3	158	PK0200	147	Q77002016	88	S5615	112
MM4479DPL	128, 131, 132	MS3500-4	158	PK0600	147	Q77002017	88	S5616	112
MM4479DSS	128, 131, 132	MS3501	158			Q77002018	88	S6112	111
MM4479E	124	MS3501-WB	158	Q0004LH	90, 91	Q77002019	88	S6312	111
MM4479EPL	128, 131, 132	MS3502	158	Q0007	59	Q77002020	88	S6401	115
MM4479ESS	128, 131, 132	MS3503	158	Q0009	59	Q77002021	88	S6402	115
MM4479F	124	MS3504	158	Q0063M	90			S6403	115
MM4479FPL	128, 131, 132	MS40302300	98	Q0063MI	91	R05102	153	S6412	111
MM4479FSS	128, 131, 132	MS4401	135	Q0063S	90	R05103	153	S6612	111
MM4479G	124	MS4402	135	Q0063SI	91			S6812	111
MM4479GPL	128, 131, 132	MS4403	135	Q0074M	90	S0080	103	S7101	108
MM4479GSS	128, 131, 132	MS4404	135	Q0074MI	91	S0088	103	S7101P	109
MM4479H	124	MS4405	135	Q0074S	90	S0089	102	S7101R	108
MM4479I	124	MS4406	135	Q0074SI	91	S0090	103	S7101T	109
MM4479J	124	MS4600	100	Q1010	59	S0200	102	S7122	108
MM4479K	124	MS46300600	97	Q1012	59	S0220	102	S7122P	109
MM4479K4	124	MS48250001	97	Q1013	59	S0280	103	S7122R	108
MM4479K6	124	MS48250600	97	Q1014	59	S0288	103	S7122T	109
MM4479L	124	MS48251000	97	Q1801	90, 91	S0289	102	S7123	108
MM4479M	124	MS48300600	97	Q18360000	86, 88, 90	S0290	103	S7123P	109
MM4479N	124	MS57215006	112	Q1836FI	91	S0400	102	S7123R	108
MM4479P	124	MS57225006	112	Q1836GI	91	S0480	103	S7123T	109
MM4479PPL	128, 131, 132	MS6030001	99	Q18480000	86, 88, 90	S0488	103	S947908	116
MM4479PSS	128, 131, 132	MS60300130	98	Q1848FI	91	S0489	102	S947908	116
MQMOUNT1	138	MS60300500	98	Q1848GI	91	S0490	103	S947908	116
MQMOUNT2	138	MS6040001	99	Q18600000	86, 88, 90	S0600	102	S947910	116
MS0202	100	MS6040002	99	Q1860FI	91	S0680	103	S947910	116
MS0421	100	MS6040100	98	Q1860GI	91	S0688	103	S947910	116
MS0421M	100	MS60401300	98	Q18720000	86, 88, 90	S0689	102	S947912	116
MS0621	100	MS60402000	98	Q1872FI	91	S0690	103	S947912	116
MS0621M	100	MS6060001	99	Q1872GI	91	S0800	102	S947912	116
MS07225006	112	MS6400	100	Q2401	90, 91	S0880	103	S9805	116
MS0904	100	MS6401	135	Q24360000	86, 88, 90	S0888	103	S9806	116
MS0914	100	MS6402	135	Q2436FI	91	S0889	102	S9807	116
MS11300600	97	MS6403	135	Q2436GI	91	S0890	103	SUTURE8	63
MS12250600	97	MS6404	135	Q24480000	86, 88, 90	S1016	112	SUTURE9	63
MS12300600	97	MS6405	135	Q2448FI	91	S1200	102	SXRD72MCATH1	61
MS1300	100	MS6406	135	Q2448GI	91	S1271	111	SXRD72MCATH2	61
MS1358	100	MS9402	135	Q24600000	86, 88, 90	S1280	103	SXRD72SCATH1	61
MS1400	100	MS9404	135	Q2460FI	91	S1288	103	SXRD72SCATH2	61
MS1402	135	MS9600	114	Q2460GI	91	S1289	102	SXRD88WSC1	62
MS1404	135	MS9640	113	Q24720000	86, 88, 90	S1290	103	SXRS72MCATH1	61
MS1600	100	MS9647	113	Q2472FI	91	S1371	111	SXRS72SCATH1	61
MS1602	135	MS9648	113	Q2472GI	91	S1400	102	SXRS88WSC1LC	62
MS1604	135	MS9654	113	Q5010SET	90, 91	S1480	103	SXRS88WSC1LS	62
MS1900	100	MS9658	113	Q70180000	86	S1488	103	SXRS88WSC1RC	62
MS1900	100	MS9660	113	Q70180001	86	S1489	102	SXRS88WSC1RS	62
MS23300600	97	MS9701	114	Q70180021	88	S1490	103	SXRSCPLBL	62
MS2400	100	MS9701S	14	Q70180022	88	S1600	102		
MS2401	100	MS9702	114	Q70240000	86	S1680	103		
MS24250001	97	MS9703	114	Q70240001	86	S1688	103	T0165	161
MS24250600	97	MS9704	113	Q77000006	86	S1689	102	T0166	161
MS24251000	97	MS9705	113	Q77000007	86	S1690	103	T0265	161
MS24300600	97	MS9706	113	Q77000008	86	S1800	102	T0266	161
MS30050012	98	MS9707	113	Q77000009	86	S1880	103	T673-9	85
MS30100004	99	MS9745	113	Q77000010	86	S1888	103	T675-9	85
MS30100006	99	MS9747	113	Q77000011	86	S1889	102	T0940	162
MS3103-HD	135	MS9748	113	Q77000012	86	S1890	103	T0970	162
MS3103-LD	135	MS9757	113	Q77000013	86	S2000	102	T1940	162
MS3200	156	MS9764	113	Q77000014	86	S2080	103	T1970	162
MS3201PC	156	MS9778	113	Q77000015	86	S2088	103		
MS3201SS	156	MT003620	161	Q77000016	86	S2089	102		
MS3202PC	156	MT003765	161	Q77000017	86	S2090	103	WB1	112
MS3202SS	156	MY0200	144	Q77000018	86	S2870	107	WB2	112
MS3205	157	MY0300	144	Q77000019	86	S3170	107	WB3	112
MS3206	155	MY0400	144	Q77000020	86	S3201BL	155		
MS3207	157	MY2000 A	145	Q77000021	86	S3210B	155		
MS3207-FC	157	MY2000 B	145	Q77002006	88	S3210G	155		
MS3208	157	MY2000 C	145	Q77002007	88	S3210GR	155		
MS3211	65	MY2000 D	145	Q77002008	88	S3210R	155		
MS3212	65	MY2000 E	145	Q77002009	88	S3210W	155		
MS3302	159	MY2000 F	145	Q77002010	88	S448021	112		
MS3302-WB	159	MY2000 G	145	Q77002011	88	S448022	112		

# CONTAINER MATERIALS

## CONVERSION FORMULAE

	TEMPERATURE RANGE	CHEMICAL RESISTANCE	MOISTURE RESISTANCE
<b>ABS</b> Acrylonitrile - Butadiene - Styrene. Thermoplastic. Very rigid and strong with good impact strength.	-20°C to +60°C	Inert to many Chemicals	Very Good
<b>PC - POLYCARBONATE</b> Thermoplastic. Very rigid and strong with good impact resistance. Transparent options available. Well suited to higher temperatures.	-40°C to +120°C	Inert to many Chemicals	Good
<b>LDPE - POLYETHYLENE</b> Low Density - Thermoplastic. Tough, light and resilient with good impact strength and recovery from distortion. Available in several grades.	-10°C to +60°C	Inert to many	Extremely Good
<b>MDPE - POLYETHYLENE</b> A tough, slightly less flexible linear medium density. Thermoplastic with good impact strength and recovery from distortion. Suitable for wide temperature use.	-30°C to +80°C	Inert to many	Extremely Good
<b>MDPE - POLYETHYLENE</b> Thermoplastic. Similar properties to high density Polyethylene. Better suited to high temperatures and has a harder surface.	-10°C to +100°C	Inert to many	Extremely Good
<b>SUPERPLAS</b> Thermoplastic material having excellent resistance to abrasion, good impact strength yet light in weight.	-10°C to +100°C	Inert to many Chemicals	Extremely Good
<b>ABS</b> Very rigid and strong with good impact strength.	-40°C to +70°C	Inert to many Chemicals	Very Good

## CONVERSION FORMULAE

TO CONVERT	MULTIPLY BY	TO CONVERT	MULTIPLY BY
Inches to Centimetres	2.54	Cu Centimetres to Cu Inches	0.06102
Centimetre to Inches	0.3937	Cu Feet to Cu Metres	0.02832
Feet to Metres	0.3048	Cu Metres to Cu Feet	35.3147
Metres to Feet	3.2808	Cu Yards to Cu Metres	0.7646
Yards to Metres	0.9144	Cu Metres to Cu Yards	1.308
Metres to Yards	1.09361	Cu Inches to Litres	0.01639
Miles to Kilometres	1.60934	Litres to Cu Inches	61.0237
Kilometres to Miles	0.621371	Gallons to Litres	4.546
Sq Inches to Sq Centimetres	6.4516	Litres to Gallons	0.22
Sq Centimetres to Sq Inches	0.155	Grains to Grams	0.0648
Sq Metres to Sq Feet	10.7639	Grams to Grains	15.43
Sq Feet to Sq Metres	0.092903	Ounces to Grams	28.3495
Sq Yards to Sq Metres	0.83613	Grams to Ounces	0.03527
Sq Metres to Sq Yards	1.19599	Pounds to Grams	453.592
Sq Miles to Sq Kilometres	2.58999	Grams to Pounds	0.0022
Sq Kilometres to Sq Miles	0.386102	Pounds to Kilograms	0.4536
Acres to Hectares	0.40469	Kilograms to Pounds	2.2046
Hectares to Acres	2.47105	Tons to Kilograms	1016.05
Cu Inches to Cu Centimetres	16.3871	Kilograms to Tons	0.0009842

**CLEANING** - Medstor materials handling products are easily cleaned using a soda based detergent. Other detergents should not be used.





# MedStor®

The heart of your storage solutions



**Mailbox**  
Stamford Products Limited

**UK:**

Bayley Street, Stalybridge, Cheshire, SK15 1QQ.

Tel: +44 (0)161 330 5577 Fax: +44 (0)161 330 5576

Website: [www.medstor.co.uk](http://www.medstor.co.uk) email: [health@medstor.co.uk](mailto:health@medstor.co.uk)

**Ireland:**

Unit 120, Grange Hill, Baldoyle Industrial Estate, Dublin 13.

Tel: +353 (0)1 839 3596 Fax: +353 (0)1 839 3468

Website: [www.medstor.ie](http://www.medstor.ie) email: [sales@medstor.ie](mailto:sales@medstor.ie)